



**Better World™**

Sustainability and Social Responsibility Report **2022**





## Overview

- 1 Chairman and CEO Message
- 4 About Dana
- 8 Climate Action
- 11 Science-led Strategy

## We value others. That's powerful.

- 14 Safety First
- 19 Diversity, Equity, and Inclusion
- 22 People Development

## Innovation. Here for it.

- 25 Technology
- 28 Global Technology Centers
- 29 Quality Signature

## Acting NOW to protect our shared planet.

- 33 Sustainability in Action
- 35 Supply Chain

## One community.

- 39 Projects Around the World

## Corporate culture matters.

- 46 Leadership
- 47 Ethics and Integrity
- 49 Cybersecurity Spotlight

## Appendix

- 51 Methodology
- 52 UN Sustainable Development Goals
- 53 Global Reporting Initiative



## Chairman and CEO Message



Photo: Jim Kamsickas, Dana Chairman and Chief Executive Officer

### Dear Fellow Stakeholders,

At Dana, we recognize that climate change is one of the most significant challenges of our time.

Sustainability is no longer on the agenda. It is the agenda.

That's why you can hear the gears shifting. Investors, customers, and employees want a long-term strategy that considers sustainability in every process.

But taking action toward sustainability is not just about doing the right thing — it's about creating a better future for ourselves and future generations.

Change begins with action. It is why we committed to be net zero by 2040, and why we are accelerating the reduction of Scope 1 and 2 greenhouse gas (GHG) emissions — with plans to achieve a more than 75 percent decrease by 2030.

---

**The details here matter because they add up to meaningful, substantive progress in our work for the planet.**

It's why we closely benchmark and monitor our supplier base to improve the sustainability performance across our supply chain — including analysis of global Scope 3 GHG emissions — and why we score our suppliers based on their ESG rating.

It's why we operate near our customers all around the world, reducing carbon footprints through shortened delivery distances.

### Taking Action

The details here matter because they add up to meaningful, substantive progress in our work for the planet. At Dana, we believe in making bold commitments, setting measurable goals and achieving them.

We are also committed to achieving targets using a science-based approach.

After the Science Based Target initiative (SBTi) validated our 2022 climate commitments, we initiated a revised SBTi validation process for our 2040 net zero target and other climate actions.

We are proud to partner with SBTi's member

---

**We believe in making bold commitments, setting measurable goals and achieving them.**

organizations — Carbon Disclosure Project, United Nations Global Compact, World Resources Institute, and Worldwide Fund for Nature — to drive sustainable best practices and lead the way to a zero-carbon economy.

In reporting annually to the Carbon Disclosure Project, a global platform working with organizations of all types to drive positive environmental changes, we support their important mission to collect, measure, and reduce global GHG emissions.

We also joined the United Nations Global Compact, focused on implementing ten principles that address important action for human rights, labor, the environment, and anti-corruption.

With respect to renewable energy, our United States wind facility became operational in

---

**We never lose sight of our guiding vision toward a zero-emissions future. This has powered Dana's first-mover advantage in electrification.**



*Our people place a focus on customer success. To embrace the art of the possible.*



December 2022 and is now generating approximately 300,000 megawatt hours of renewable electricity annually, offsetting 100 percent of Dana's emissions from purchased electricity in the United States and Canada.

We also completed a renewable power purchase agreement with Enel Green Power for an upcoming solar project in Spain. The agreement, commencing January 2025, will supply Dana with approximately 240,000 megawatt hours per year of renewable energy, offsetting 100 percent of Dana's emissions from purchased electricity in Europe.

#### **Innovation. Here for it.**

In a year where the technology we make touched more lives than ever, Dana teams never stopped innovating to protect the planet.

Dana technologies have won the *Automotive News* PACE Awards five times and been named as finalists on 24 occasions — recognizing our pipeline of innovative driveline, sealing, thermal, and digital solutions.

Across all our actions at Dana, we never lose sight of a guiding vision toward a zero-emissions future.

This has powered our first-mover advantage in electrification. We strategically invest in technical competence — designing, engineering, and manufacturing the components of a complete e-Propulsion system in-house.

***Further, 65 percent of our new business backlog now comes from innovating next-generation clean-energy technologies.***

The electric powertrain in a vehicle can be compared to the human body where system components work in a highly sophisticated and integrated manner to ensure optimal performance.

When we talk about e-Propulsion, we refer to the complete electric driveline as a 4-in-1 system. Here, Dana's e-Motor is analogous to the heart, providing the power required for movement. Our inverter acts as the brain, controlling and coordinating the flow of electrical energy.

Dana's e-Thermal management technology can be compared to the circulatory system, regulating temperature and distributing heat. Finally, Dana's core mechanical torque transfer capability, built on our foundational businesses, can be thought of as the muscle.

When you put all this together, Dana is the only supplier that has in-house capabilities to deliver such fully integrated systems to the entire mobility market, anywhere in the world.

This is a fundamental differentiator in supporting adoption of EVs. We have completely repositioned the business to support our customers' clean-energy priorities.

In 2022, we were selected to support fully integrated e-Propulsion systems for all-new EV programs for global vehicle manufactures across all mobility markets.

Dana continues to differentiate in customer confidence and satisfaction evidenced by Dana TM4™ electric motors exceeding 2.8 billion customer miles (4.5 billion kilometers) driven in our Commercial Vehicle segment alone.



Further, 65 percent of our new business backlog now comes from innovating next-generation clean-energy technologies.

Such innovations include efficient EV systems and new electrodynamic products like motors, inverters, controls and software, battery cooling systems, and metallic bipolar plates for fuel cell applications.

**We value others. That's powerful.**

120 years ago, Clarence Spicer opened the doors to Spicer Manufacturing. His partnership with Charles Dana — our company namesake — matched Dana's business acumen with Spicer's innovative genius.

The rest, as they say, is history.

***This idea of teaming up to make a better world — of winning together — underpins everything we do at Dana.***

We are 42,000 people in more than 30 countries and truly at the center of a world in motion.

During 2022, we were named among "America's Most Responsible Companies" by *Newsweek* for four consecutive years, reflecting our culture of doing business with the highest ethical standards.

Echoing this theme, we were recognized as one of the "2023 World's Most Ethical Companies®" by Ethisphere, a global leader in defining and advancing the standards of ethical business practices. A total of 135 companies spanning 19 countries and 46 industries were recognized — with Dana as one of only eight honorees across the mobility industry.

These acknowledgments celebrate our company's unwavering commitment to business integrity, to operating the business the right way.

They spotlight our dedication to sustainability and social responsibility, our communities, employee health and wellness, and inclusion and diversity. They also illuminate the work we do around the design, sourcing, and manufacturing of clean-energy products.

**It's One Dana**

We create empowering environments for our employees through our "One Dana" teamwork and people-first practices.

This has led to recognition by *Newsweek* as "America's Greatest Workplaces for Diversity 2023" and from the Top Employers Institute and the Great Places To Work Institute.

These awards reflect the performance of Dana's operations in Belgium, China, Germany, Hungary, India, Italy, Lithuania, Mexico the Netherlands, Sweden, Switzerland, the United Kingdom, and the United States representing more than 80 percent of our employees and sales.

Above all, our people place a focus on customer success. To embrace the art of the possible.

What gives me hope is a mindset of resiliency that underscores everything we do across Dana. Creating more sustainable practices that strengthen our changing world.

It is a privilege to witness their remarkable talent. I am humbled by their work and grateful for their contributions.

My personal best,



**James K. Kamsickas**  
Chairman and Chief Executive Officer





About Dana

# By the Numbers

**1904**

History dating to **1904**

**88**

**88** major manufacturing facilities

**1,600+**

**1,600+** electrification-related patents granted or pending

**\$10.2B**

2022 Sales of **\$10.2 billion**

**9**

Global network of technology centers across **9** countries

**31**

Presence in **31** countries

**42,000**

**42,000** employees globally

**13,000+**

Shipping to more than **13,000** customers in 141 countries

**6**

Presence on **6** continents

## Business Units

### Light Vehicle Drive Systems

Dana is a leading supplier of fully integrated drivetrain and electrified propulsion systems for all passenger vehicles. Working collaboratively with original-equipment manufacturers and the aftermarket, we focus on delivering best-in-class efficiency, maximum durability, and superior ride and handling across the globe.

### Commercial Vehicle Drive and Motion Systems

Dana is an industry leader in the supply of traditional and electrified systems for medium- and heavy-duty commercial vehicles. We help original-equipment manufacturers and end-market customers achieve the best weight, performance, and efficiency, as well as the lowest cost of ownership, no matter the powertrain configuration.

### Off-Highway Drive and Motion Systems

Dana delivers mobile drivetrain and motion solutions for construction, agriculture, material handling, and mining equipment, as well as motion systems for a wide variety of mobile and stationary industrial applications. These customized solutions support vehicles and machines with both conventional and electrified power sources and are designed to deliver innovative technologies that serve customers worldwide.

### Power Technologies

Dana provides advanced thermal-management and sealing solutions to all end markets in support of conventional, electrified, and fuel-cell platforms. Leveraging the most cutting-edge technology and manufacturing processes, we deliver custom-engineered solutions designed to optimize efficiency and performance.



About Dana

# 2022 Sales

By Region

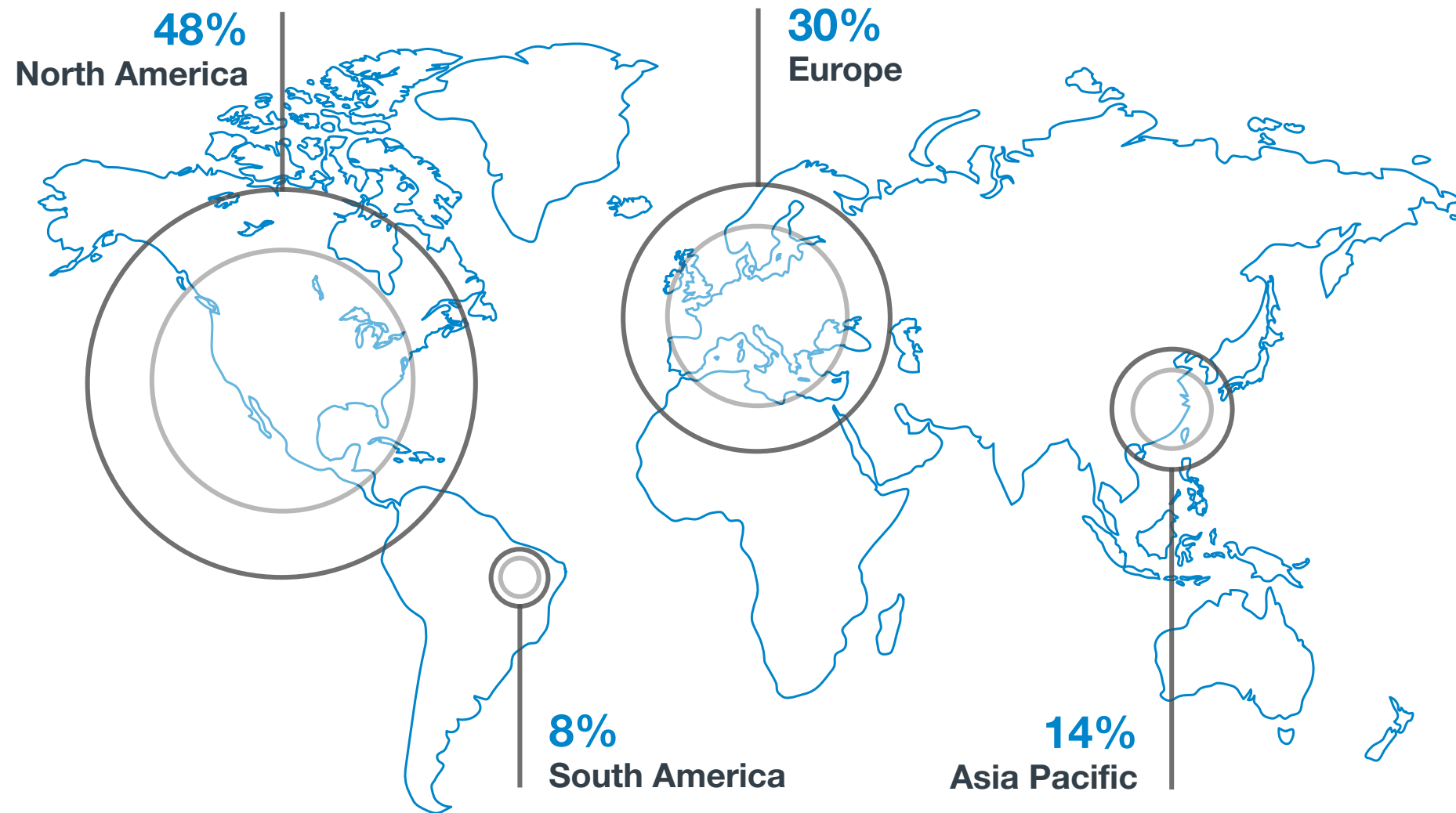

Sales as of Dec. 31, 2022. Consolidated sales only.

By Customer

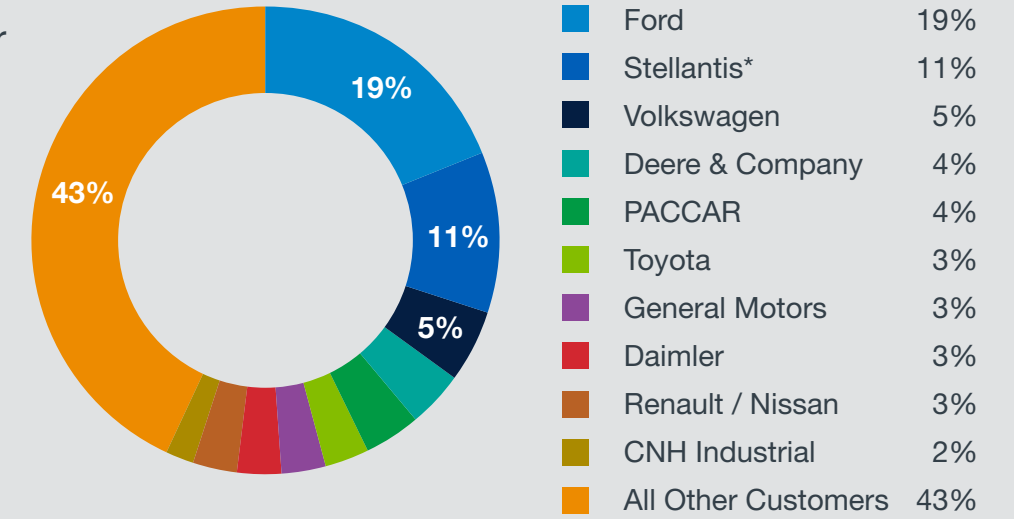

\* Includes sales to system integrators for driveline products that support Stellantis vehicles.

By Segment

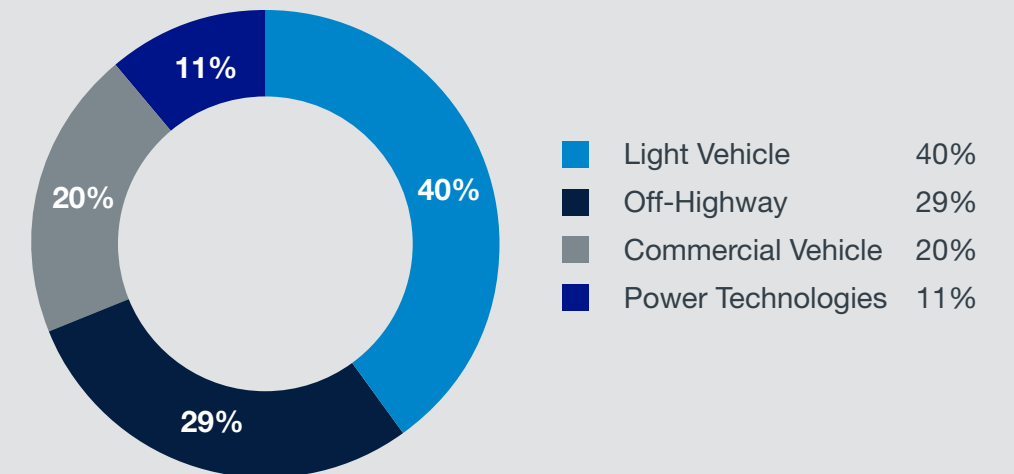

By Market

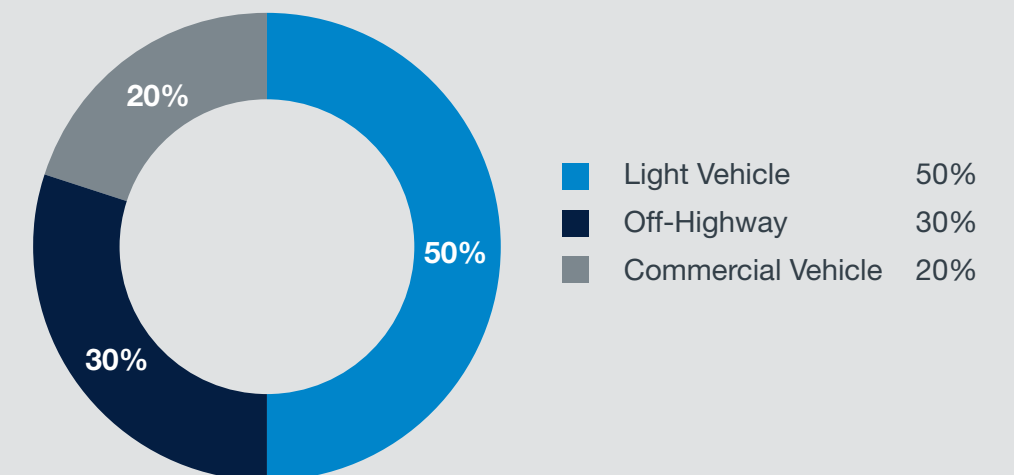



About Dana

# Employment Data

## Gender

Employees by Employment Type and Gender

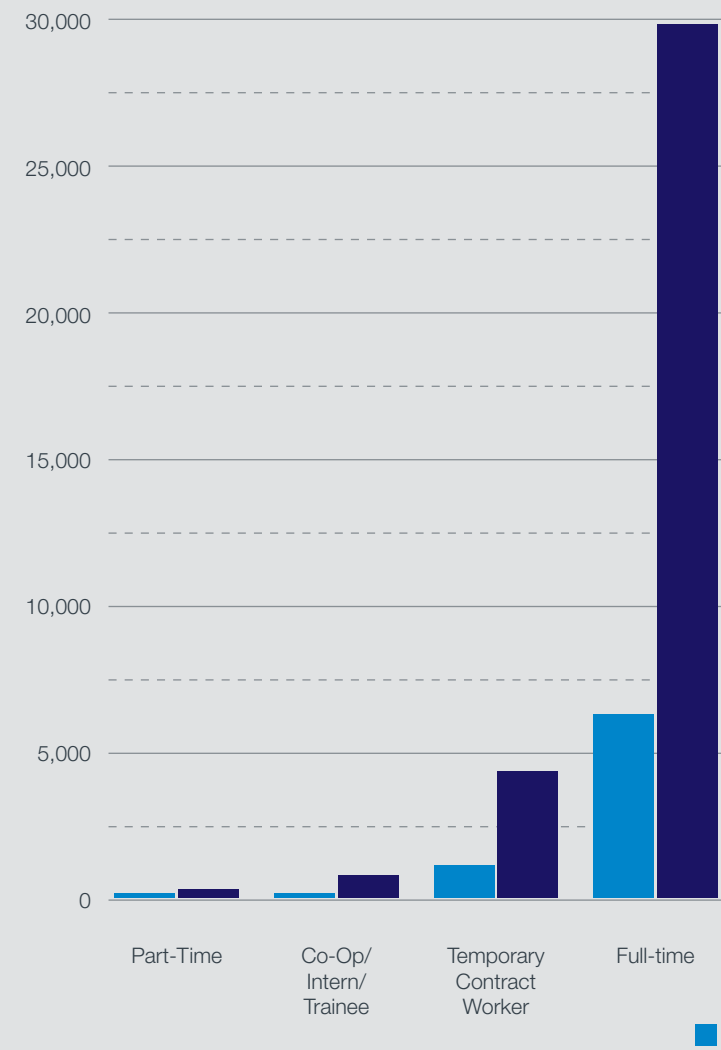

Employees<sup>1</sup>

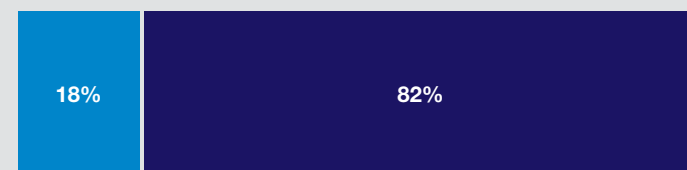

New Hires

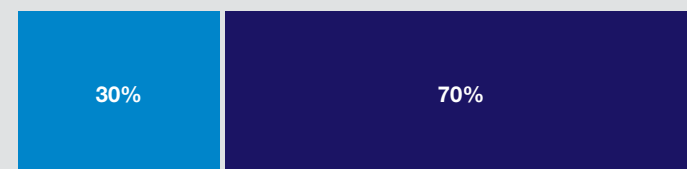

Attrition

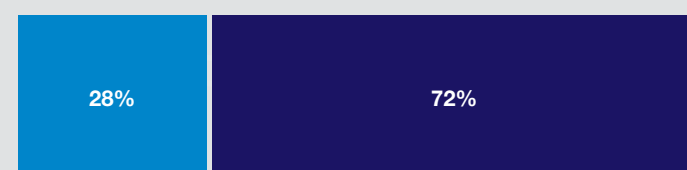

## Region

Employees<sup>1</sup>

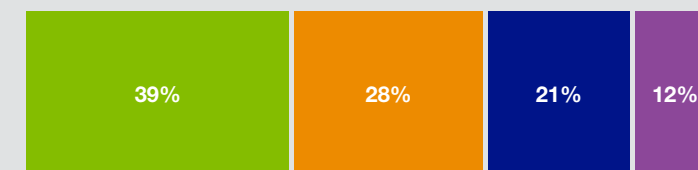

New Hires

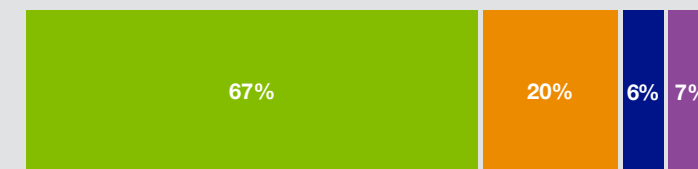

Attrition

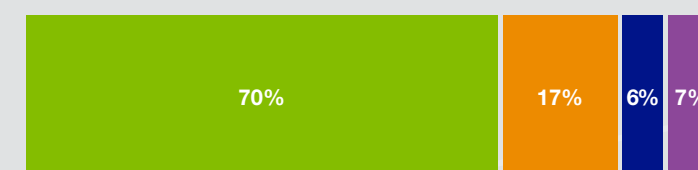

North America Europe Asia Pacific South America

## Age

Employees<sup>2</sup>

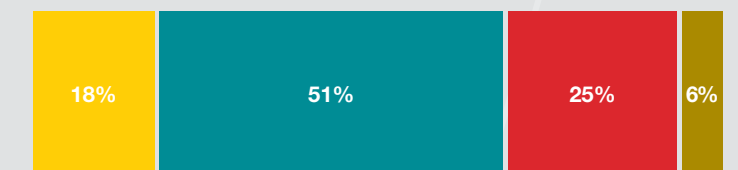

New Hires<sup>2</sup>



Attrition<sup>2</sup>

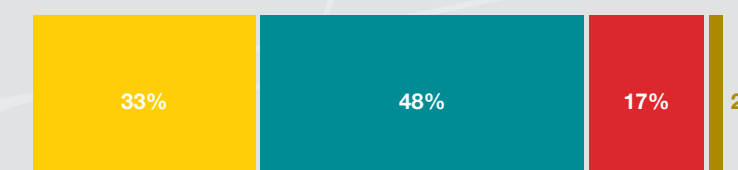

Under 30 30 - 50 Over 50 Unknown/Not Provided

<sup>1</sup> Per headcount policy, vendor service workers, JV unconsolidated, employees on unpaid leave or layoff are excluded from headcount

<sup>2</sup> Date of birth is not available for certain types of employment classifications (e.g., contractors) and therefore in these instances age is unknown or not provided



About Dana

# Awards

## Dana Recognized as one of the “2023 World’s Most Ethical Companies®” by Ethisphere

The comprehensive assessment process included research into Dana’s culture, environmental and social practices, ethics and compliance activities, governance, diversity, and initiatives that support a strong value chain.

Dana is one of only eight honorees across the mobility industry, and one of a total of 135 companies globally to receive this recognition.



[Read more about this award.](#)

## Dana Named “Top Employer 2023” in 12 Countries, Earns Distinction for its European Operations

The Top Employers Institute recognized Dana as a “Top Employer 2023” in 12 countries around the world. The company’s European region was also collectively named a Top Employer. This prestigious award honors exceptional human resources programs, including diversity and inclusion, work environment, talent acquisition, learning, and well-being.

Dana’s operations in Belgium, China, Germany, Hungary, India, Italy, Lithuania, the Netherlands, Sweden, Switzerland, the United Kingdom, and the United States were identified as being a Top Employer for creating an empowering environment for employees through people-first practices. Because of the high number of operations earning the honors in Europe, Dana was also selected as a Top Employer for that region.

[Read more about these awards.](#)



## Newsweek Names Dana One of “America’s Most Responsible Companies” for Fourth Consecutive Year and one of “America’s Greatest Workplaces for Diversity”



Additionally, Dana was recognized as one of “America’s Greatest Workplaces for Diversity,” recognizing the company’s impact and commitment to building a culture that supports and embraces diversity.

The inaugural award results were based on a detailed analysis of publicly available data, interviews with human resource professionals, and an anonymous online survey of a diverse pool of employees, covering a broad range of key drivers of employee satisfaction.

These included corporate culture, proactive management of a diverse workforce, sustainability and awareness, compensation and benefits, training and career progression, work-life balance, working environment, and company image.

[Read more about this award.](#)

Dana has been named to *Newsweek* magazine’s “America’s Most Responsible Companies” list every year since its inception, marking the fourth consecutive year for the honor.

Based on a detailed analysis by *Newsweek* and its partner, Statista, the listing reviews the corporate social responsibility efforts of the 2,000 largest public companies by revenue, including each company’s business practices in environmental, social, and corporate governance categories.



# Climate Action

75%+

Reduction of Scope 1 and Scope 2 GHG emissions by 2030

25%+

Reduction in Scope 3 GHG emissions by 2030

2040

Net zero



SCIENCE BASED TARGETS

DRIVING AMBITIOUS CORPORATE CLIMATE ACTION

Managing with Science Based Targets





# Global Energy Efficiency Savings 2019-2022

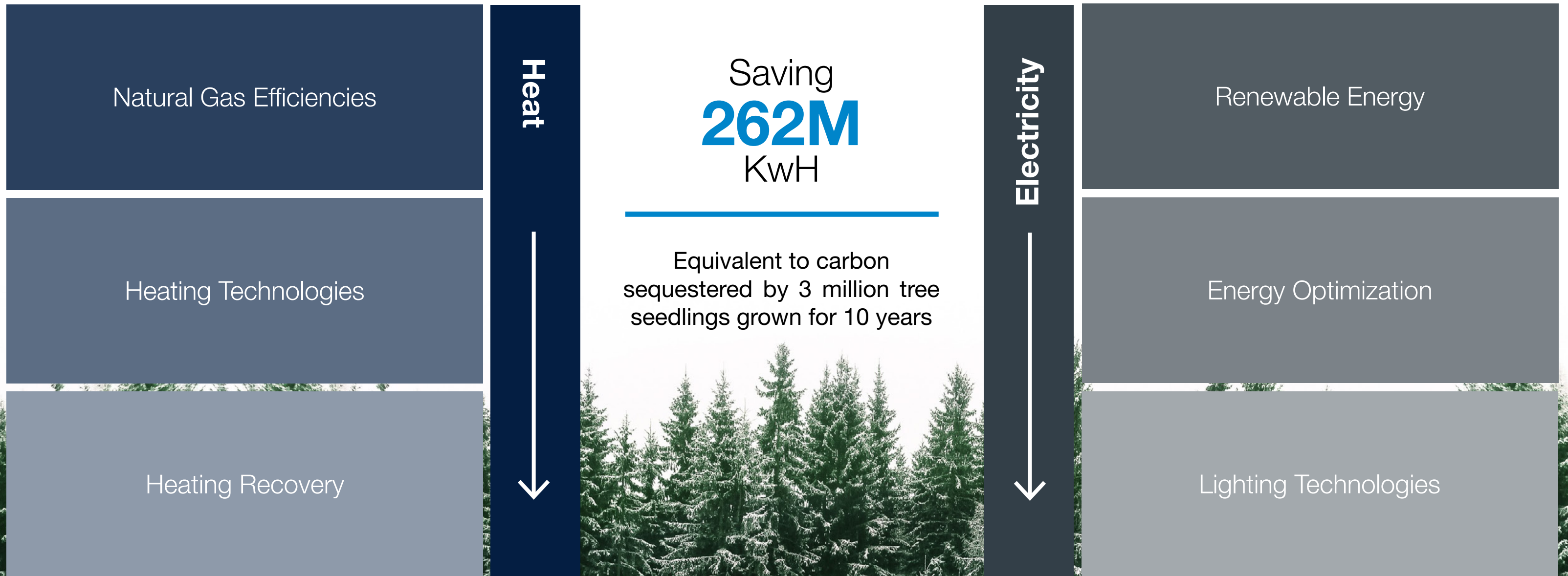



# Acting **NOW** to Protect Our Shared Planet



## Changing Our World Through e-Propulsion

Powering a zero-emissions future with our first-mover advantage in electrification.

65% of Dana's new business backlog comes from innovating next-generation clean-energy technologies including efficient EV systems, new electrodynamic products, thermal management technologies, and metallic bipolar plates for fuel cell applications.

## Actioning Renewable Energy

Installing on-site and off-site renewable energy generation technologies globally.

Examples include offsetting 100% of Dana's emissions from purchased electricity in the United States and Canada. From 2025, we will offset 100% of emissions from purchased electricity in Europe.

## Greening Our Operations

Advancing environmental management systems with 100% of Dana's major manufacturing sites now ISO 14001:2015 certified.

Promoting ISO 50001:2018 energy management certification globally and recognition as green buildings for new facilities.

## Driving a Responsible Supply Chain

Using ESG data gathering and scorecards for global sourcing. Collecting Scope 3 GHG emissions, carbon footprint, and product lifecycle reviews for select suppliers.

Developing sustainable alternatives through global commodity strategies and engaging with suppliers via collaboration and training.

## Protecting Water Resources

Progressing hundreds of global efficiency projects each year across Dana. Including water reduction and reuse programs, rainwater harvesting, and working with communities to advance the biodiversity of rural and urban areas by promoting clean water and conserving ecosystems.

## Financing and Manufacturing Sustainably

Driving the transition to a low carbon economy through investments in electrification via a \$400M green bond offering.

Advancing climate action including a net zero 2040 GHG emissions target with validation by the Science Based Targets initiative.



**Better World™**



Science-led Strategy

# Leading by Example

Tackling climate change is one of the most important challenges of our generation.

We lead by example, not only in the clean-energy technologies and products that we deliver, but also in how we operate our business — all with a focus on improving the environment.

We help build a better future for everyone we encounter and the planet that enables us to do our work.

**Powering Innovation**

We have navigated through 120 years of vehicle evolution and have helped to shape the electrification revolution for decades.

Further, 65 percent of our new business backlog now comes from innovating next-generation e-Propulsion systems and other clean-energy solutions.

We're proud to be the only supplier with the in-house capabilities necessary to deliver all the elements of a complete, fully integrated electrified system — across all mobility markets — anywhere in the world.

**Being Better**

We're reducing our global Scope 1 and 2 annual greenhouse gas (GHG) emissions by more than 75 percent by 2030.

**How?**

- By lowering our overall energy consumption.
- By entering into renewable energy purchase agreements offsetting 100 percent of Dana's emissions from purchased electricity in the United States and Canada.
- And from 2025, offsetting 100 percent of Dana's emissions from purchased electricity in Europe.
- By driving efficiency improvements across our operations.
- By sourcing renewable energy from on-site solar arrays around the world.
- By working collaboratively with our suppliers to drive sustainability improvements across our global supply chain.

**Advancing Together**

By delivering the clean-energy technologies powering vehicles and machines around the world, we are supporting our customers to achieve their sustainability priorities, while also reducing our global Scope 3 GHG emissions.

**Driving Transparent, Verifiable Claims**

We are committed to openly disclosing our ESG commitments and progress, and to being led by science-based methods. We are an industry leader, partnering with the world's foremost organizations to report on our climate impact actions.

By joining the Science Based Targets initiative and the Carbon Disclosure Project, we collaborate with others for the greater good and look forward to continuing our work with customers, suppliers, and others toward a sustainable future.

**Supporting Our Vision**

We have strategically invested and continue to invest to secure unparalleled technical competence in designing, engineering, and manufacturing the components of a complete e-Propulsion system in-house.

**Total Energy Consumption**  
(MWh)

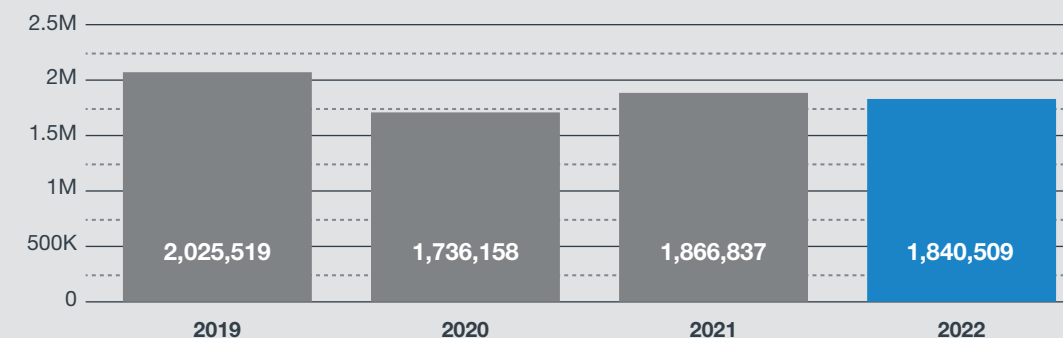

**Total Greenhouse Gas Emissions**  
(kg CO<sub>2</sub>-e)

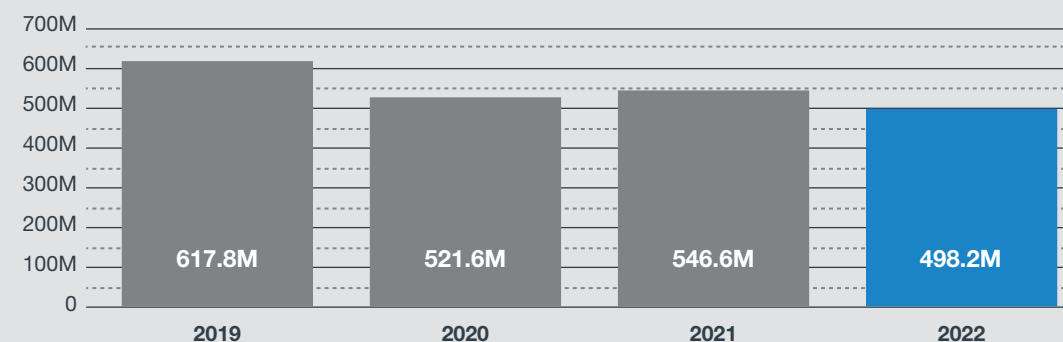



## Science-led Strategy

# Sustainability Action

We know it is essential to accurately measure and report on our climate commitments.

This means setting specific targets and goals for reducing greenhouse gas emissions (GHG) and then tracking progress towards these goals using transparent and reliable methods.

By doing so, we hold ourselves accountable and demonstrate our commitment on climate action.

### How You Measure Matters

We have remained an industry leader by joining the Science Based Target initiative (SBTi), a global “gold standard” organization, validating ambitious, science-based emissions reduction targets.

In 2022, the SBTi validated our climate commitments. Thereafter, we initiated a revised SBTi validation process for our 2040 net zero target and other climate actions with them. These include a reduction of Scope 1 and 2 GHG emissions by more than 75 percent by 2030.

We are proud to partner with SBTi’s member organizations — Carbon Disclosure Project, United Nations Global Compact, World Resources Institute, and Worldwide Fund for Nature — to drive sustainable best practices and lead the way to a zero-carbon economy.

### Carbon Disclosure Project

We report annually to the Carbon Disclosure Project (CDP), a global platform working with organizations of all types to drive positive environmental changes.

We are proud to support CDP’s important mission to collect, measure, and reduce global GHG emissions.

### Improvement Always

We leverage our robust environmental management systems to drive continuous improvement across the organization including initiatives to reduce water, energy consumption, waste, and emissions.

We also reuse and recycle to minimize our environmental footprint. These measures are part of our overall approach to regularly assess Dana’s environmental compliance to ensure that we always operate to industry-leading standards.

### Global Reporting Standards

Consistent with our commitment to disclose Dana’s sustainability and social responsibility performance, we comply with leading global reporting standards including: the Global Reporting Initiative (GRI), the Sustainable Accounting Standards Board (SASB), and the Task Force on Climate-related Financial Disclosures (TCFD).

### Recognition

Dana received the inaugural Sustainability Award in Automotive from the ATZ/MTZ Group and Roland Berger for its Holistic Sustainability Approach. The award recognizes companies with developed mobility solutions that take the environment and resources into account in a future-oriented and sustainable manner.

It focuses on products, processes, and initiatives that have a holistic impact on sustainability in the automotive industry.

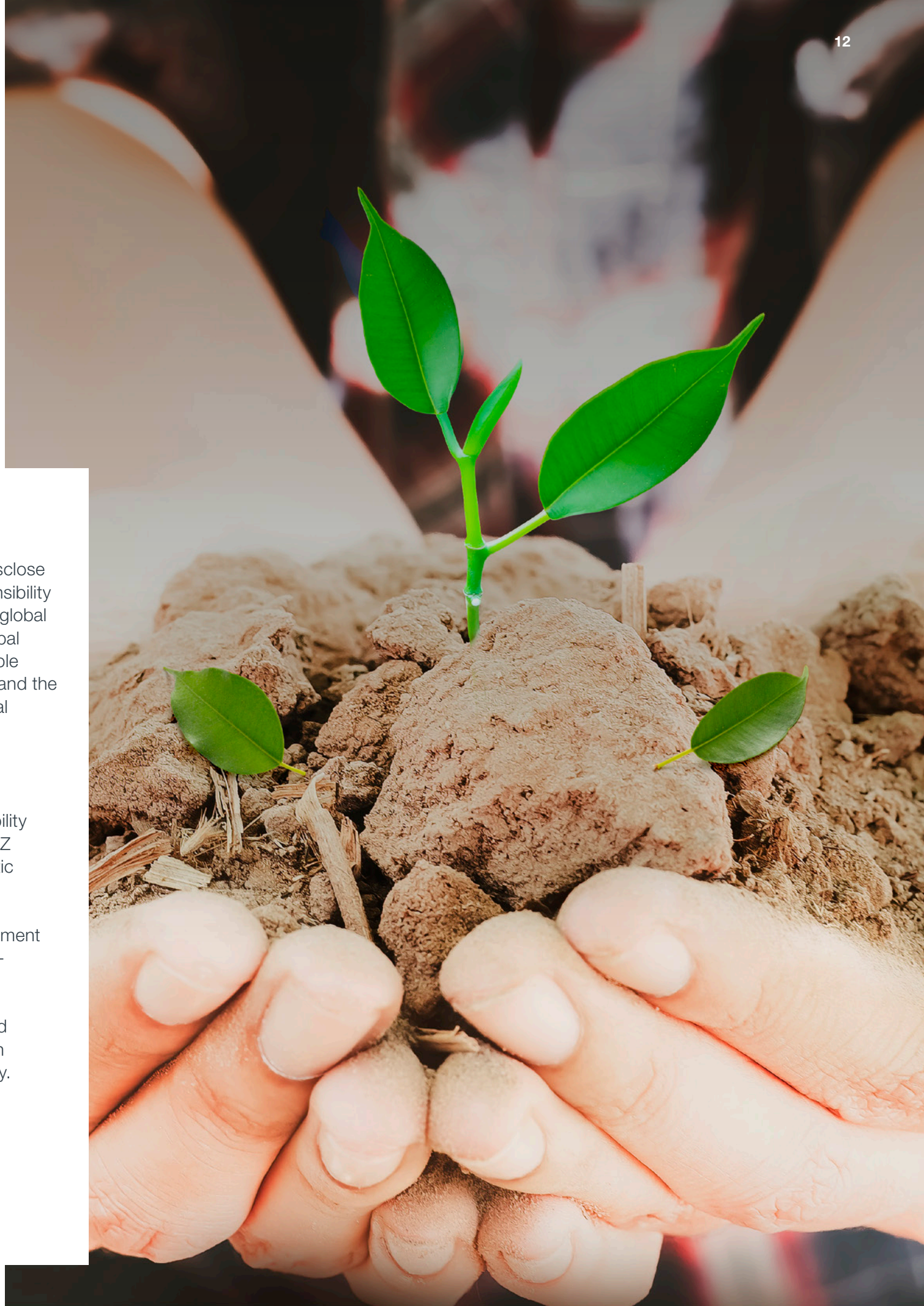



A photograph of three factory workers in a blue-tinted industrial setting. The workers are wearing safety glasses and work clothes. The woman in the center is wearing a blue jumpsuit with a 'TM4' tag. The man on the left is wearing a black polo shirt with a 'DANA' logo. The man on the right is wearing a black t-shirt. The image features digital overlays, including a large blue arc with arrows at the top and a blue diamond pattern at the bottom. The text 'We value others. That's powerful.' is overlaid in white, with 'value' highlighted in a blue box.

**We value others.  
That's powerful.**





Safety First

# Safety First

At Dana, we care.

Safety culture refers to the values, beliefs, attitudes, and behaviors that determine our commitment to safety in the workplace.

At Dana, safety culture is driven by a strong commitment from leadership, employee involvement, training and education, continual improvement, and open communication.

We believe that Dana has an essential accountability to safeguard life, health, property, and the environment. We achieve this by consistently committing to excellence in safety, health, and security management by advancing risk identification and control methodology.

Through feedback and fostering open communication, we actively promote and pursue safety in all that we do.

Our “Safety First” approach requires a daily, focused effort.

### Commitment

Successful safety programs start with leadership commitment with clarity around roles and responsibilities throughout the organization.

Dana’s approach focuses on people, culture, performance, and results, and all stakeholders — both internal and external — have a role to play.

With leadership promoting the development of health and safety processes, all employees are responsible to act in ways that demonstrate safety awareness, hazard control, and loss prevention for the benefit and protection of all involved.

Dana Global Recordable Incident Rate

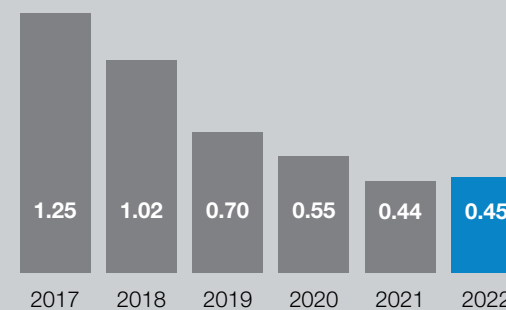

Dana Global Lost Time Recordable Incident Rate

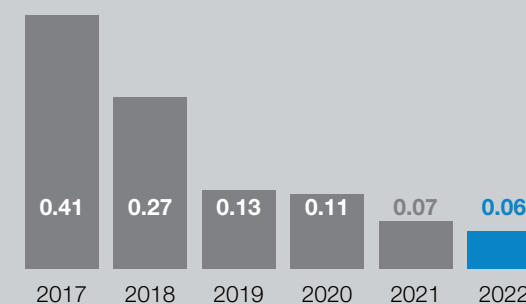

# Dana Safety Certified

The Dana Safety Certified training program provides a platform to continually elevate the collective safety knowledge of all employees.

During 2022, our people successfully completed more than 45,000 safety training programs as part of this initiative.

Specifically focused on Environment and Human Health, Safety, and Security (EHSS) topics, the program is rolled out across four levels.

Each of these — from Safety 101, to Silver, to Gold, and Diamond — adds additional training requirements and skills.



Safety 101 is our comprehensive foundational course focused on safety culture, safe behaviors, Dana’s “Life Safety Rules,” our individual role in safety, and resources available to assist in ensuring a safe work environment.

Silver courses spotlight our Life Safety Rules with Gold courses dedicated to additional life safety critical topics.

Diamond courses are focused on advanced safety, health, security, and environmental themes — including behavioral safety, environmental awareness, job safety analysis, and office safety among others.





Safety First

# ISO 45001:2018 Certification Goal Achieved

Dana Sustainable Mobility Center  
Maumee, Ohio, United States

## We strive for continual improvement.

It's an essential element in today's competitive and rapidly changing business environment.

We felt that the next evolution in our safety journey was to pursue registration to the world's first international occupational health and safety management standard — the International Organization for Standardization® (ISO) 45001:2018.

Therefore, in 2018, Dana committed to all our major manufacturing facilities achieving ISO 45001:2018 certification – a process that focuses on establishing an effective and auditable occupational health and safety management system that is continually reviewed and improved upon.

Setting safety management system goals is critical for achieving safety objectives, holding individuals and teams accountable, encouraging continual improvement, and enhancing our safety culture.

ISO 45001:2018 Certification ensures that our safety management system is regularly audited by third party registrars across the globe.

This standard follows a Plan-Do-Check-Act model, providing a framework for organizations to assess what they need to put in place to minimize the risk of harm.

### 100% Completion

As of December 31, 2022, 100 percent of the manufacturing sites included in our original goal had achieved this certification — establishing an effective occupational health

and safety management system integrated with other measures to attain our strict health and safety objectives.

ISO 45001:2018 certification also facilitates internal improvements and provides third-party validation that Dana is focused on the safety and well-being of our people.

We are committed to maintaining ISO 45001:2018 registration for all certified facilities complying with audited occupational health and safety management system requirements.

With respect to environmental management systems, 100 percent of Dana's 2018 manufacturing site footprint is now ISO 14001:2015 certified. Going forward, we plan to obtain both certifications for all new major manufacturing sites within two years of adding to our operations.

# EHSS Education Drive

Education and training are essential tools powering health, safety, and productivity.

Around the world, our people understand workplace risks and how to identify, report, and control them.

It's why Dana makes safety education a top priority and an integral part of all new employee orientation programs.

We tailor our training to be impactful, emphasizing a culture of open, honest communication where people feel comfortable discussing concerns and making suggestions.

We spotlight the important role of people managers across Dana. And emphasize their responsibilities and the procedures for responding to employee reports of injuries, illnesses, and incidents.

### Winning as One

Safety is a shared responsibility.

Consequently, employees have a significant role to play in ensuring their own safety, integrating this mindset into their daily activities.

To this end, our education and training program instructs around how to report injuries, illnesses, incidents, and concerns.

### Special attention is given to:

- A thorough review of all applicable company safety rules, policies, and procedures; particularly Dana's Life Safety Rules as well as those relevant to each work area.
- Training in techniques for identifying potential hazards, such as job safety analysis.
- Understanding the safety hierarchy of controls and how to prioritize different types of controls to eliminate or minimize risks. This systematic approach ensures that the most effective control measures are executed to protect our people.
- Additional training as necessary around changes in facilities, equipment, processes, materials, or work organization whenever new tasks are undertaken.
- A full understanding of the importance of open communications in the health and safety management process.



### Safety First

# CEO Safety Award

The CEO Safety Award is granted to the facility demonstrating the most outstanding safety performance during 2022.

Our winner — Power Technologies Thermal facility in Győr, Hungary — exemplifies the true meaning of a safety-first culture.

Through outstanding teamwork and meticulous execution, the facility promotes a proactive mindset where everyone is quick to recognize issues and intervene, if needed.

Plant leadership and the EHS team have worked together to build a strong culture of leading from the operations floor and maintaining an open-door policy where employees are encouraged to share ideas for improvement.

The facility surpassed more than 1.7 million hours – equaling two-and-a-half years – without a lost-workday incident.

The judging panel noted high-scoring on their 2022 Health and Safety Assessment and achievement of ISO® 45001:2018 and 14001:2015 certifications.

The team are pursuing ISO 50001:2018 certification — with Stage 1 complete and preparations for Stage 2 underway.



Photo of Power Technologies Thermal facility in Győr, Hungary

“Dana is founded on strong values that place our people at the heart of everything we do. We win together, pursue excellence, and encourage unique perspectives.”



**Jaime Meyer**

Senior HR Manager, United States



Safety First

# 1 Million+ Hours

Without a Lost-Time Incident in 2022

**North And South America**

In 2022, 29 major manufacturing locations in North and South America achieved significant milestones for working safely.

**1 Million+ Hours**

- Cambridge, Canada
- Danville, United States
- Gravataí, Brazil\*
- Humboldt, United States
- Oakville, Canada
- Pottstown, United States
- Querétaro, Mexico
- Sorocaba, Brazil
- Sterling, United States
- St. Clair, United States
- Warren, United States

**2 Million+ Hours**

- Dry Ridge, United States
- Gordonsville, United States
- Lafayette, United States
- Querétaro, Mexico

**3 Million+ Hours**

- Columbia, United States
- Apodaca, Mexico

**4 Million+ Hours**

- Gravataí, Brazil
- Louisville, United States
- Mount Forest, Canada
- Paris, United States
- Querétaro, Mexico\*
- Tlalnepantla, Mexico

**5 Million+ Hours**

- Chihuahua, Mexico
- Grand Bourg, Argentina
- Tlalnepantla, Mexico
- Toluca, Mexico



\* Indicates instances where there is more than one Dana major manufacturing facility in a particular city.  
Data represents hours worked without a lost-time incident recorded at a major manufacturing facility as of December 31, 2022



Safety First

# 1 Million+ Hours

Without a Lost-Time Incident in 2022

**Europe and Asia**

In 2022, 24 major manufacturing locations in Europe and Asia achieved significant milestones for working safely.

**1 Million+ Hours**

- Åmål, Sweden
- Guiscard, France
- Győr, Hungary\*
- Itziar-Deba, Spain
- Luserna, Italy
- Pamplona, Spain
- Pune, India
- Rayong, Thailand
- Rudrapur, India
- Weifang, China
- Zaragoza, Spain

**3 Million+ Hours**

- Belgaum, India
- Chennai, India
- Satara, India

**4 Million+ Hours**

- Ladkrabang, Thailand
- Fuzhou, China
- Neu-Ulm, Germany
- Wuxi, China

**2 Million+ Hours**

- Birmingham, United Kingdom
- Pantnagar, India

**5 Million+ Hours**

- Jodalli, India
- Noida, India
- Chakan, India

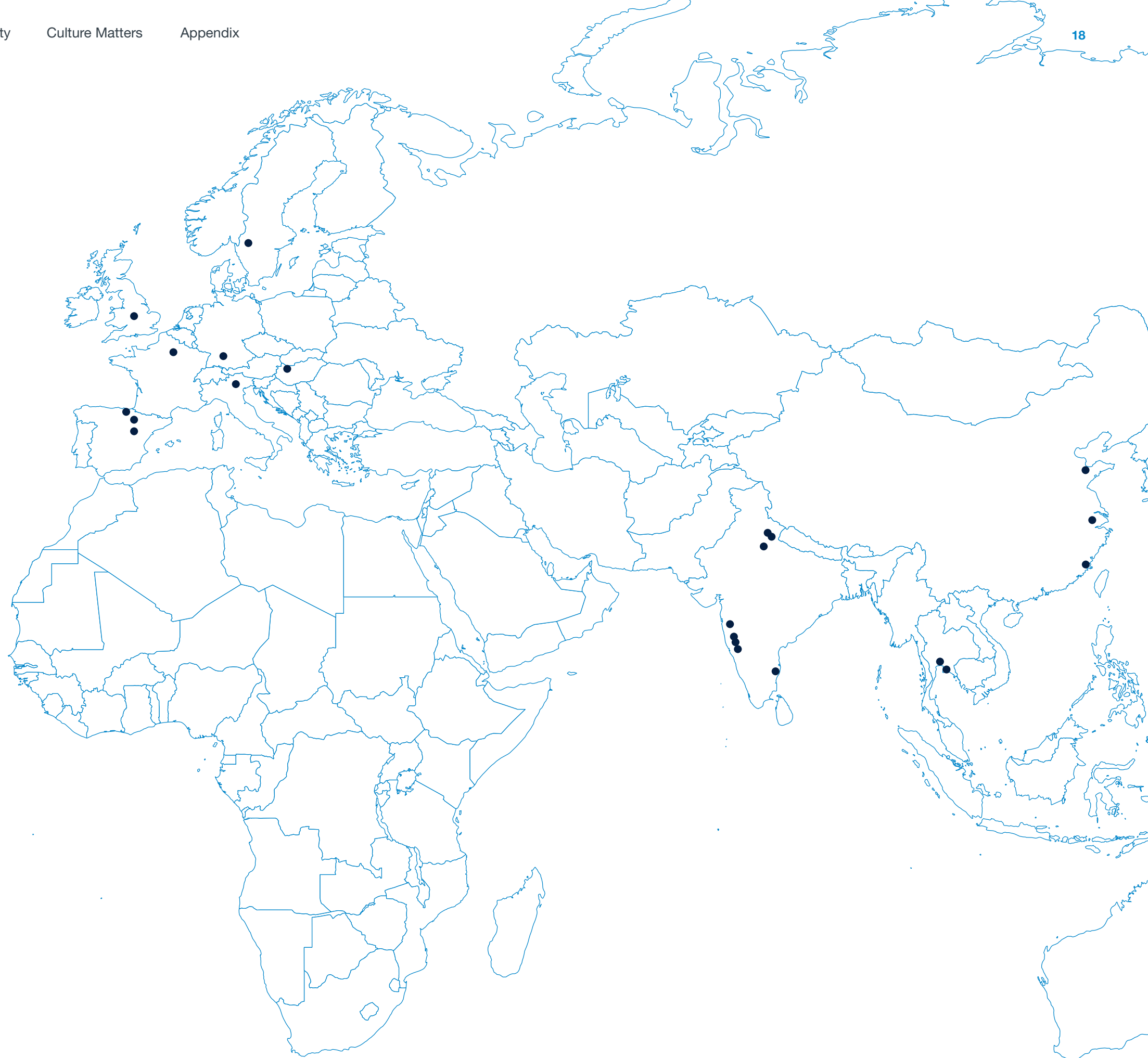

\* Indicates instances where there is more than one Dana major manufacturing facility in a particular city. Data represents hours worked without a lost-time incident recorded at a major manufacturing facility as of December 31, 2022



## Diversity, Equity, and Inclusion

# Leading With Diversity, Equity, and Inclusion

At Dana, we continuously build upon our diverse strengths. We cultivate a strong and inclusive culture where all our people have opportunities to thrive.

By developing a diverse organization, we attract outstanding talent with industry experience promoting both curiosity and innovation from all our 42,000 employees across 88 major facilities in 31 countries.

### Inclusive and Equitable

We are dedicated to ensuring safe, respectful, and inclusive workplaces where everyone can contribute, participate, and thrive.

We commit to providing fair and equitable opportunities based on employees' individual talents and to facilitating the resources people need so that they can access developmental opportunities.

While diversity refers to the qualities that make people unique, inclusion refers to the Dana behaviors that ensure people feel welcome.

We know that people are different and we respect those differences — including age, gender, ethnicity, religion, disability, sexual orientation, education, national origin, and other dimensions of diversity that are not as readily apparent.

Creating a fair, diverse, and inclusive workplace informs who we look to bring into the organization and how we develop people once they are here.

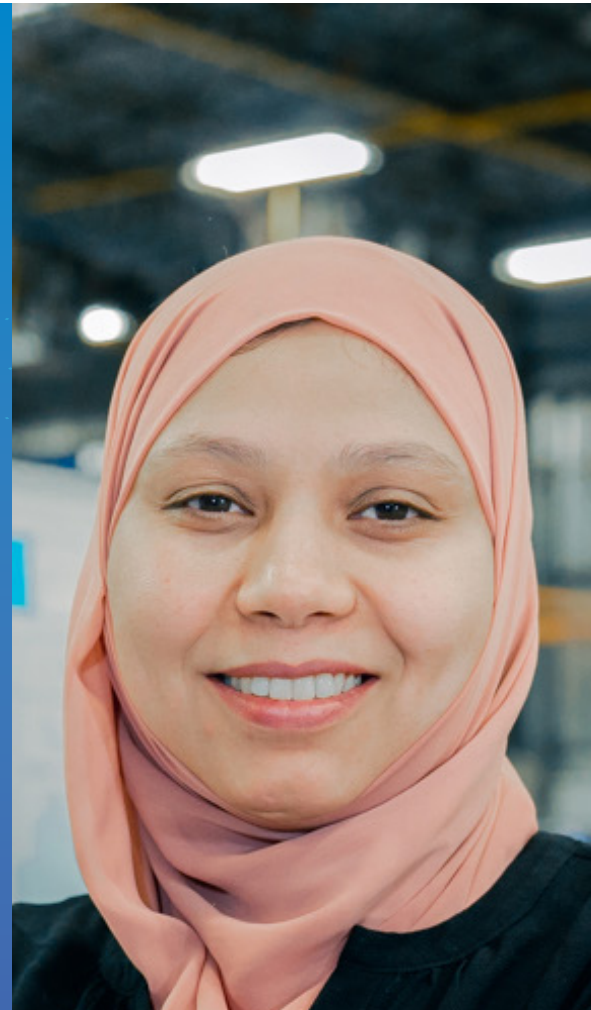

While diversity refers to the qualities that make people unique, inclusion refers to the Dana behaviors that ensure people feel welcome.

Employee from Boucherville, Québec, Canada

# Diversity, Equity, and Inclusion Governance Committee

Dana's Diversity, Equity, and Inclusion Governance Committee is regionally structured — Asia Pacific, Europe, Latin America, and US/Canada — and aims to develop mechanisms and strategies to continually enhance a supportive, inclusive, and diverse workplace.

Among the goals and objectives are:

- Assisting Dana leadership in driving diversity strategy, goals, and key milestones.
- Identifying and formulating recommendations for programs, policies, and work practices that affect recruitment and retention of a diverse workforce.
- Advancing transparent processes to access developmental and advancement opportunities, and prioritizing education programs that build diverse and inclusive competencies and awareness.
- Acting as advocates of Dana's diversity, equity, and inclusion strategy.

Progress by the Diversity, Equity, and Inclusion Governance Committee is reported at least five times annually to Dana's Board of Directors.



## Diversity, Equity, and Inclusion

# Pillars of Strength

Dana's diversity, equity, and inclusion strategy is guided by five pillars.

### Representation

We set goals. Building internal and external talent pipelines and expanding our diversity recruitment, retention, and promotion efforts to increase varied representation.

We use transparent, data-driven talent practices and decisions to help mitigate bias and equip our leaders with the tools, information, and support necessary to achieve their objectives.

### Education

We advance with a strong focus on diversity, equity, and inclusion education for all employees to ensure that we have the cultural awareness and understanding necessary to successfully build and retain diverse and inclusive teams.

We connect with third-party organizations such as the Center for Automotive Diversity, Inclusion and Advancement, among others, to provide our Business Resources Groups (BRGs) with the tools to promote leadership and the resources designed to inform and engage.

Our partnerships with other organizations such as the CEO Action for Diversity and Inclusion and the Charta der Vielfalt in Europe create educational components to support our people along their education journeys.

### Development

We offer development programs to empower employees in realizing their career aspirations. And provide them with a clear understanding of how to build their careers at Dana.

We also partner with consulting firms to create world-class development programs including a focus on mentorship and leadership.

Importantly, these programs align with our annual performance appraisal and individual development planning process. It's not just what we achieve — but how we get there that counts.

### Community

Dana communities are places where we live, work, and play. We partner with local communities around the world to advance more diverse hiring practices.

We champion our BRGs which are voluntary, employee-led groups formed around shared identity, interests, and pursuits. They represent and support the diverse communities that make up our workforce and are open to all employees.

We know that every decision counts. Therefore, in sourcing materials for the products that we make, we drive sustainability and social responsibility as a key part of every purchasing outcome.

This includes our detailed evaluation process analyzing key considerations such as diversity, equity, and inclusion considerations (diversity ownership of our supplier base) as well as sustainability and social responsibility factors.

### Cross-functional Collaboration

We focus on people and supplier development, compensation, engagement, attraction, and retention to collaborate cross-functionally and ensure that inclusive and equitable structures and work practices are rooted in all Dana processes.

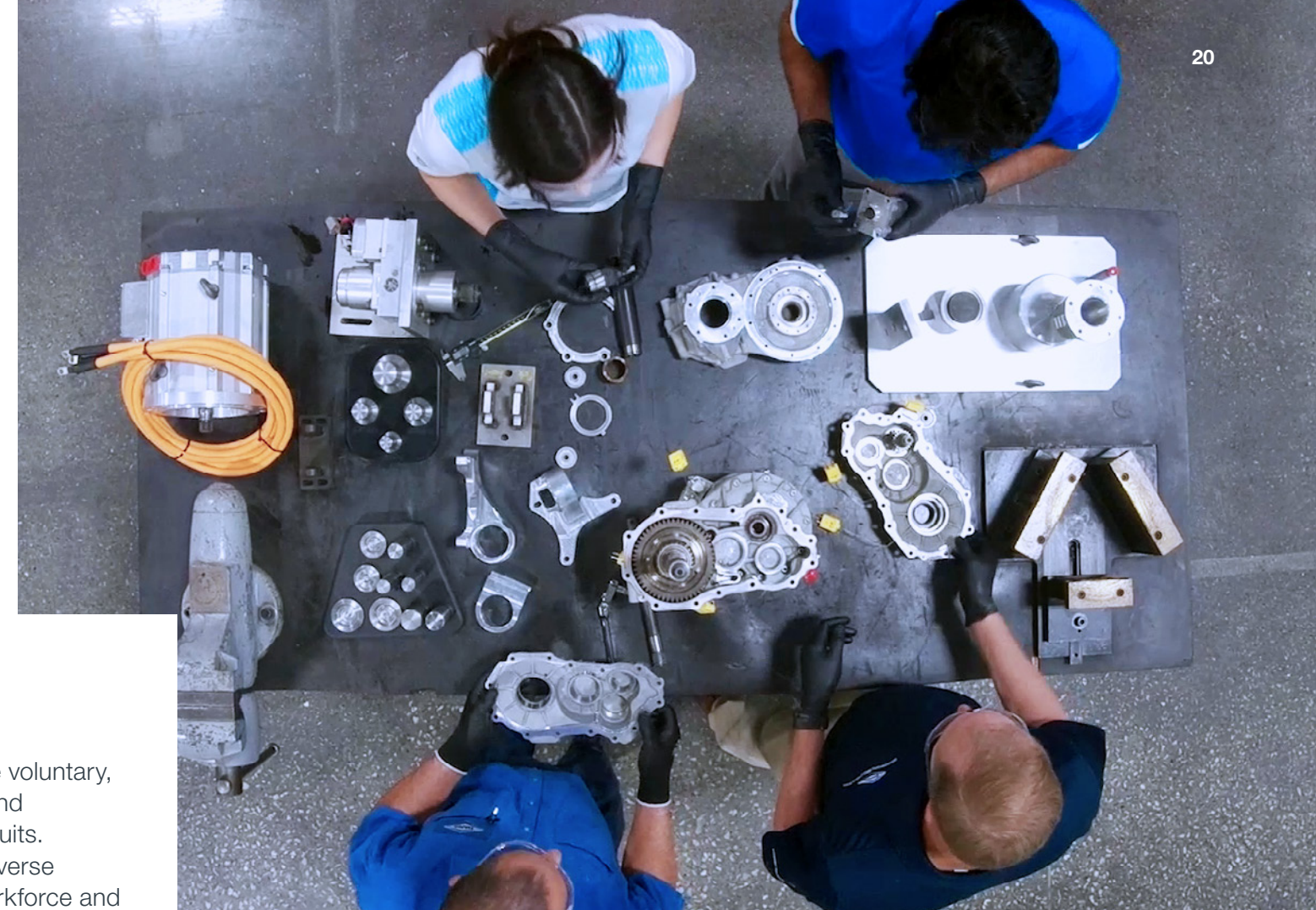

## Day of Understanding

Dana's Day of Understanding was coordinated as part of our CEO Action for Diversity and Inclusion pledge.

This pledge outlines a specific set of actions organizations are taking to cultivate a trusting environment where all ideas are welcomed, and employees feel comfortable and empowered to have discussions about diversity and inclusion.

At Dana, our locations around the world selected a day from mid-April to mid-May to launch conversation starters on various diversity and inclusion topics. There were videos with discussion guides and employees signed a personal diversity and inclusion pledge to help drive inclusive behaviors in their everyday life.

Equity was added to the Day of Understanding sessions, to continue conversations for the diversity, equity, and inclusion process.

These training programs call for each of us to take a personal look at our own predispositions, conscious or non-conscious, and to engage in practical steps to recognize and overcome them.





# Diversity, Equity, and Inclusion

## Our Business Resource Groups

*As a global organization, our people mirror perspectives and opinions from different cultures, backgrounds, and experiences.*

We are powered by a variety of viewpoints and voices, enabling us to solve problems more quickly, to think creatively, and ultimately to drive continuous improvement and profitable growth.

As such, we continue to promote and provide visibility to our Business Resources Groups (BRGs).

This network fulfills our commitment to valuing others, lending a voice to the diversity we have across Dana and increasing the engagement of both our current and retired employees.

By embracing diversity, equity, and inclusion, we create an environment that inspires the best from everyone and maximizes the value of our most important asset — the collaboration of our people.

These eight BRGs are executive leadership supported, employee-led initiatives with the mission to inspire growth and innovation and foster diversity, equity, and inclusion.

- African American Resource Group
- Connecting Cultures Resource Group
- Dana Alumni Resource Group
- Dana Women's Network (DAWN) Resource Group
- Green Team Resource Group
- LGBTQA Resource Group
- Military and Veterans Resource Group
- New To Dana Employee Resource Group

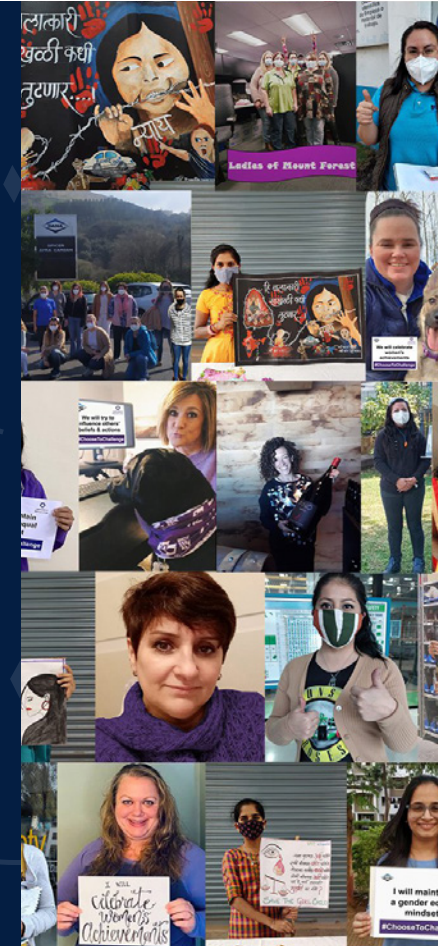

### International Women's Day 2022

Dana Women's Network (DAWN) Resource Group advances the promotion of professional networking and career development through mentoring, education, and philanthropy for women.

During International Women's Day, DAWN's United States chapter facilitated a panel discussion with our leadership team to discuss allyship from male employees, mentoring, and the challenges of working while raising children, among other topics.

The global Dana community participate in International Women's Day by wearing purple and identifying how they #BreakTheBias.

Other similar events led by Dana women and DAWN members around the world spotlighted appreciation for women across our locations, and mentoring in STEM applications to inspire girls to become the next generation of engineers and researchers.

“By leading the ‘New to Dana Group,’ I help new hires build relationships, making a 42,000-strong company like Dana feel as one.”

#### Stephanie Roy

Senior Sustainability Specialist, United States

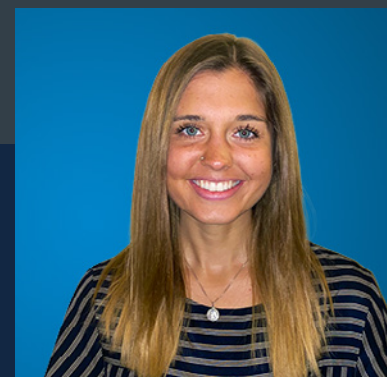



## People Development



At Dana, we provide career development, fair wages, and benefits, and see our people’s contributions being valued — adding to the long-term success of their career goals.

To enable our People Finding A Better Way spirit, we encourage collaborative innovation and foster open communications — gathering feedback via engagement surveys, skip-level discussions, and interaction with our leadership team.

### Programs

Our Employee Value Proposition highlights the way people work at Dana showcasing our work environments, culture, development opportunities, and employee recognition.

And our development programs offer immersive, hands-on learning experiences for college graduates to accelerate careers in finance, human resources, purchasing, and engineering.

In the United States for example, participants on the program worked on assignments in different areas of their respective functions over a five-year period to drive opportunities for leadership roles.

And we continue to provide on-demand programs for employees around the world.

### SkillPort

Thousands of our people completed training in Dana’s SkillPort portal, offering a wide variety of instruction for employees looking to build their skills in topics such as management, communication, diversity and inclusion, quality, and safety.

### FranklinCovey

Training for 7 Habits of Highly Effective People™ was expanded to global locations increasing the capacity of leaders to their manage teams. And

the Speed of Trust® module spotlighted the power of trusting in others.

### Learning Journeys

Our Learning Journeys continue to be an important asset offering essential online training sessions utilizing some of the most requested and accessed training across safety, quality, diversity, equity, and inclusion.

### Connecting Through Diversity

We continue to grow our diversity sourcing and recruitment programs to provide strong candidates for the organization.

Our efforts are focused on impacting key groups that we measure from a representation standpoint, namely women and minorities.

We also remain committed to recruiting across other key communities and groups, such as the LGBTQ and our military and veteran communities.

We continue to track progress against our interviewing policy, which requires gender and racial / ethnic diversity among external candidates at director-level and above in the United States.

### Quality Trainings

To support Dana’s Quality Focused initiative, two trainings were created.

One offering an introduction and overview and the second to expand on Dana’s Life Quality Rules — key elements underpinning the initiative.

Each course was developed in two formats, to be both delivered online and also presented in a

group setting at the local level. Both formats were translated into 20 languages to ensure we reach our global audiences.

The Respect in the Workplace module, part of the Operational Leadership training program, was made more interactive. And we incorporated facilitator notes and scripts so that it could be used by local leaders as a separate training program — reinforcing Dana’s expectation of a respectful and inclusive working environment.

### Mentoring

Senior leaders around the world support Dana’s commitment to accelerating our people’s development through formal and informal mentoring partnerships.

Increasing confidence, broadening perspectives, expanding personal and professional networks, and identifying career paths count as some of the many benefits for Dana mentees.

Our focus on mentoring is also extended to our communities.

For example, members of Dana’s African American Resource Group volunteer as mentors for high-school and university students, as well as members of the National Society of Black Engineers.

Mentoring students helps to attract the best diverse talent and is also an opportunity for Dana mentors to develop and reinforce their leadership capabilities and give back to our communities.



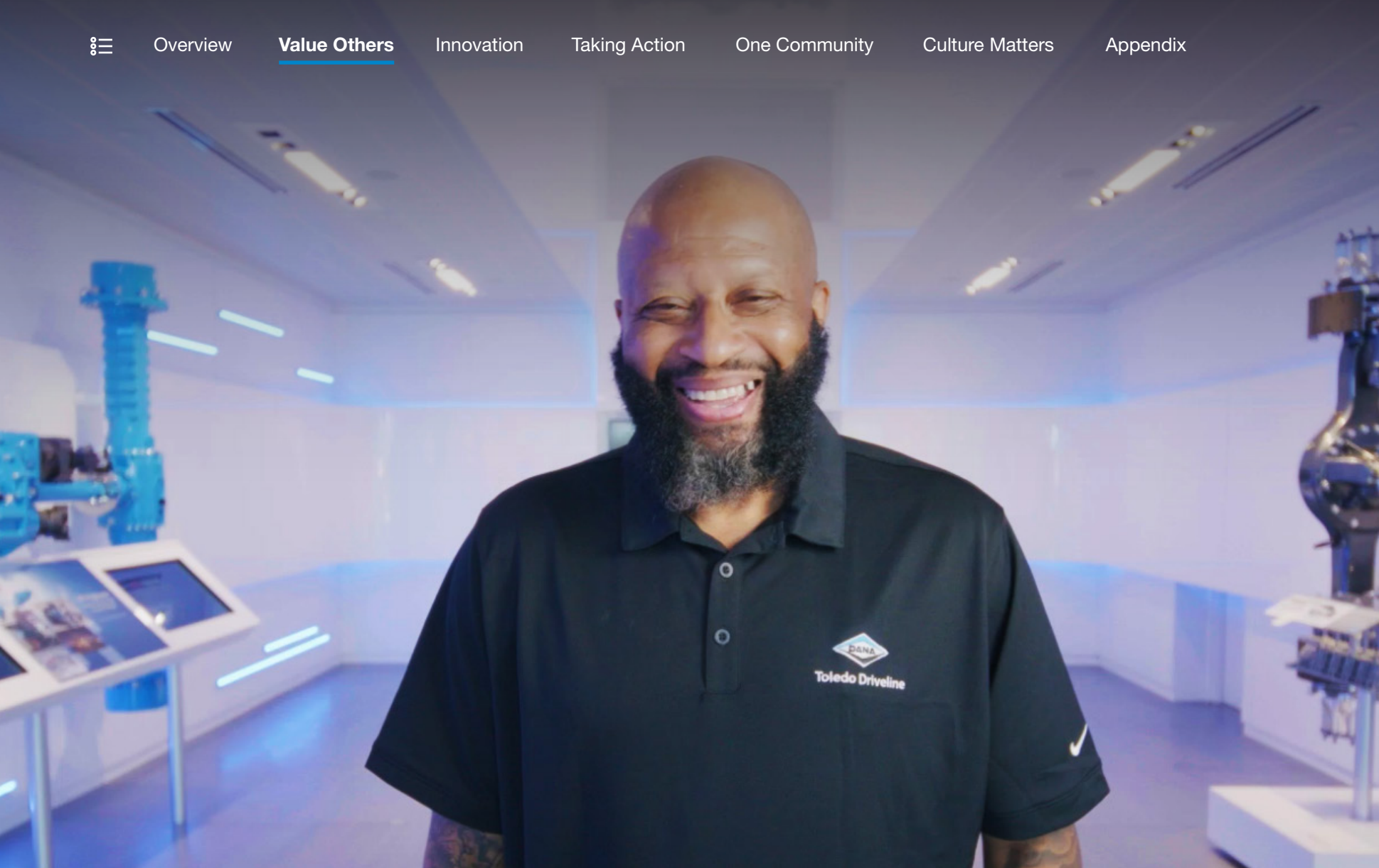

“Since starting with Dana, employee engagement has been my top priority. Showing appreciation, gaining trust, and building a team to drive the change our world needs.”



**Sydney Raber**

HR Manager, United States

# Health and Well-being Spotlight

Health and well-being initiatives have long-lasting impacts, including enhancing creativity, resilience, job satisfaction, and work-life balance.

For Dana, this means a more vibrant workforce, increased morale, talent retention, and a robust future for the company.

Dana believes in:

- The importance of striving for personal and work-life integration.
- A supportive work environment that cultivates the drive to succeed.
- The importance of exploring new opportunities across the health and well-being spectrum.

We are committed to providing all employees with quality and competitive benefit programs that focus on all aspects of employee well-being — including physical, mental, and financial. Our plans are benchmarked annually to ensure fit, competitiveness, and value.

Dana programs meet a wide range of needs and services related to the well-being of employees and their families. For example,

many of our locations have retirement plans ranging from pensions to tax-deferred retirement savings plans.

Around the world, we provide financial wellness programs offering employees the opportunity to meet with financial counselors to help them learn about a variety of financial situations that may impact them — including budgeting, savings, and retirement planning.

## Employee Assistance Program

In addition to Dana’s traditional Employee Assistance Program services, we provide further educational opportunities for employees to better understand ways to improve their mental health during and after challenging times.

To reduce stigma around mental health issues, Dana facilities around the Toledo, Ohio, United States area participated in an Out of the Darkness community walk. This was an opportunity to discuss and acknowledge the ways in which mental health conditions have affected our lives and the lives of others in our communities.

Across Dana, local mental health resources around the world offer employees more information on where to find the support they may need.





**Innovation.  
Here for it.**



### Complete e-Propulsion System

Dana Earns 2022 *Automotive News* PACE Award for Integration of Complete BEV e-Propulsion and e-Power Systems



*Automotive News* recognized Dana with a 2022 PACE Award for the Spicer Electrified™ Complete Battery Electric e-Propulsion and e-Power System. Now in its 28th year, the prestigious PACE Awards program recognizes suppliers for game-changing technologies that deliver superior innovation, technological advancement, and business performance.

Dana's fully integrated electric vehicle solution leverages the company's core technologies in electric vehicle architecture, vertically integrated systems engineering, and core product portfolio in integrated electric systems to accelerate the time to deliver vehicles to market.

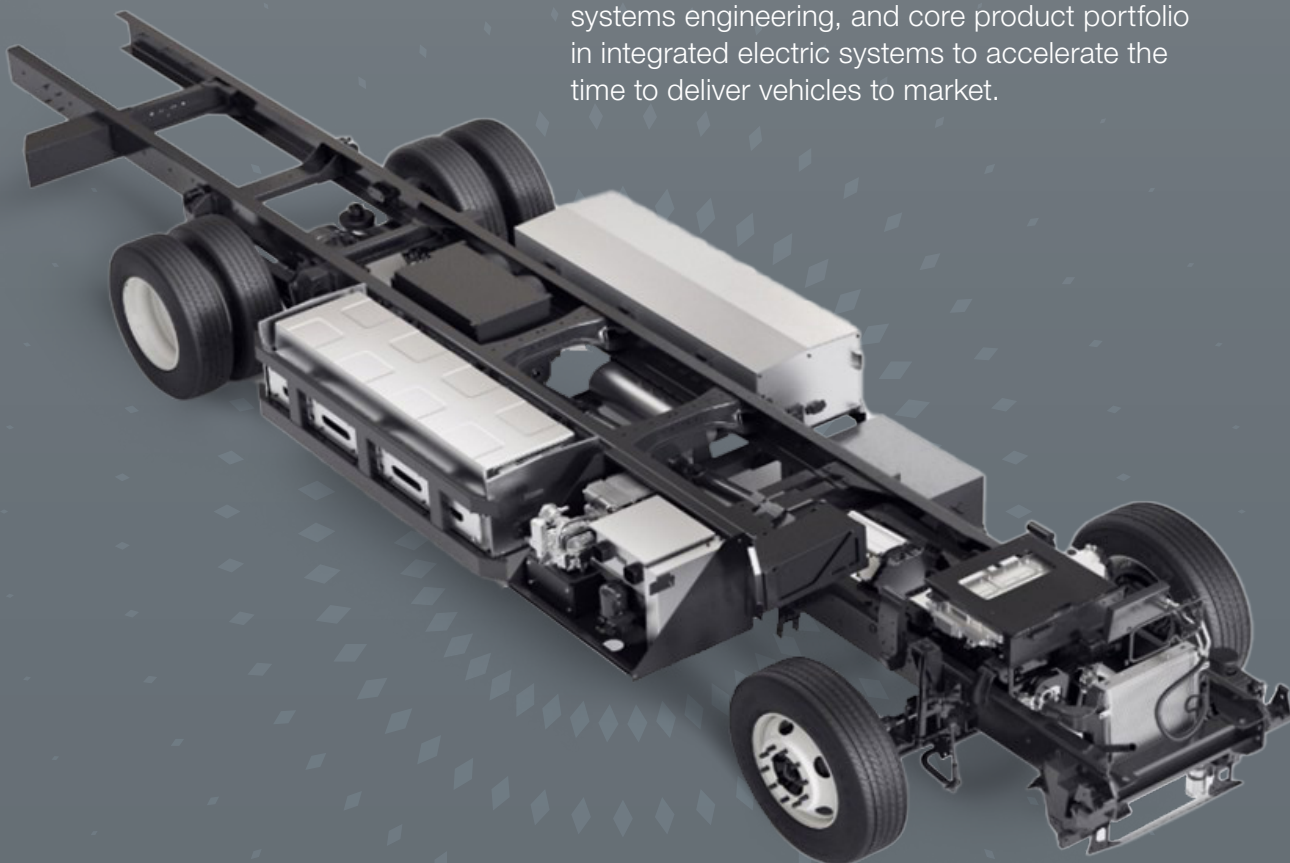

### ThermaTEK™ Battery Cold Plate

Dana Supports New-Energy Vehicle Programs with Innovative Battery Cooling

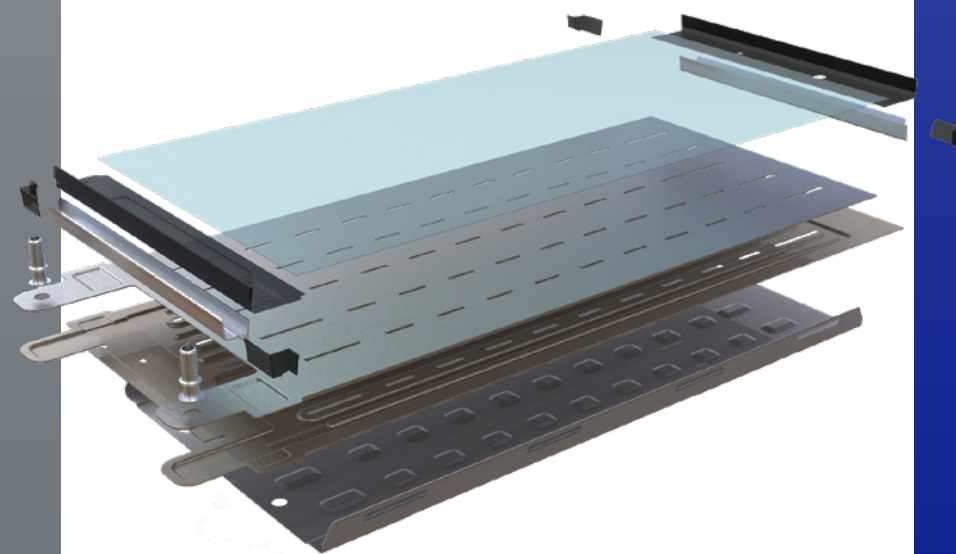

Leveraging 120 years of thermal-management expertise, Dana continues to innovate and advance its electric battery cooling technologies.

The company was recently selected to supply its ThermaTEK™ battery cold plates and electronic module cooling systems for major new-energy vehicle programs such as Jaguar Land Rover's next-generation global electric-vehicle platforms, the Ford F-150 Lightning, the Rivian all-electric pickup truck, and the General Motors Ultium program, which serves as the foundation of the company's electrical architecture.

### Dana TM4™ CO150 Inverter

Long-term Agreement Established with Lion Electric

Underscoring its focus on electrification, Dana confirmed its strategic supply relationship with Lion Electric Co. to support its lineup of electric buses as well as medium- and heavy-duty trucks. The agreement covers the supply of the electric drive systems, including electric motors, inverters, and controllers, as well as axles and driveshafts for all Lion Electric platforms, including the LionA, LionC, LionD, LionM, Lion6, and Lion8.

Dana supplies Lion with a broad range of technologies and systems, including the Dana TM4 SUMO™ family of electric motors supporting light-, medium-, and heavy-duty applications; Dana TM4™ medium- and heavy-duty high-voltage inverters; medium- and high-

voltage bi-directional charger inverters that function as both a battery charger and inverter; the fully programmable OpenECU™ M5 series of vehicle controllers for use as the main vehicle management unit; and a range of single-reduction and tandem drive axles and driveshafts for direct-drive configurations.

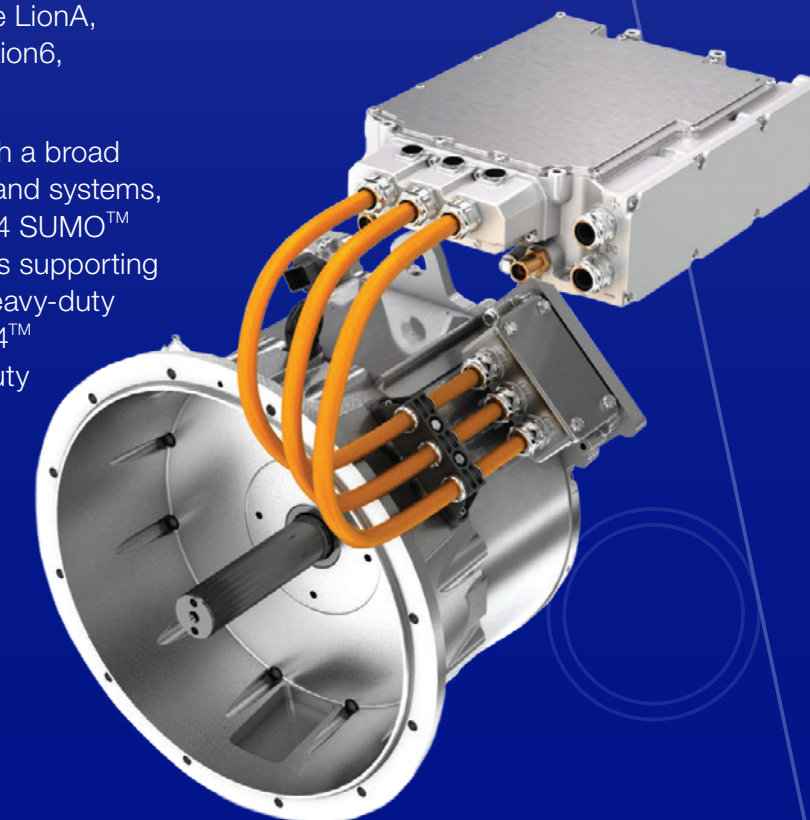



### Spicer Electrified™ eSP502 e-Transmission

## New Spicer Electrified™ e-Transmission Supports Off-Highway Vehicles

Leveraging Dana’s powershift technology, the new Spicer Electrified™ eSP502 e-Transmission is a flexible platform designed to support the electrification of vehicles across the construction, mining, material handling, and forestry markets. The eSP502 e-Transmission offers a dual-motor, two-speed design that is built on a flexible platform to enable optimized performance at maximum efficiency in a compact package.

The modular approach to the transmission design allows for a single motor solution, as well as an optional power take-off, depending on the specific vehicle requirements. The eSP502 comes with next-generation control software and functional safety readiness, enabling easy installation and smooth integration, and it features a patented clutch design that minimizes clutch drag to maximize efficiency.

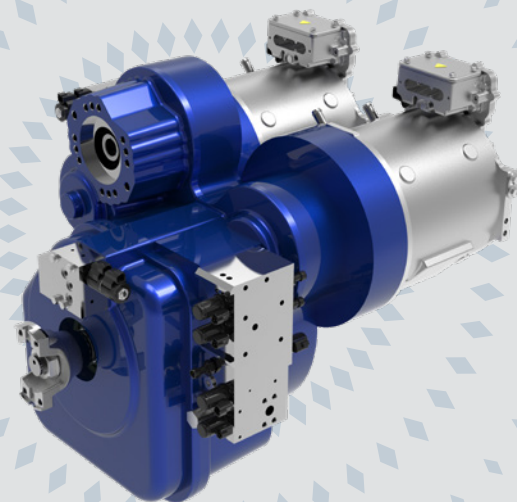

### Dana Spicer Electrified™ TM4 SUMO™ LD system

## Dana’s Spicer Electrified™ Motor and Inverter System Powers New Ultra4™ EV Race Series

Dana’s Spicer Electrified™ motor and inverter system were featured on the custom-performance vehicles competing in the new Ultra4™ electrified vehicle (EV) racing series. The powerful Spicer Electrified™ TM4 SUMO™ LD motor and inverter system developed for off-road vehicles showcased how well electrification performs in the extreme conditions that Ultra4 racing presents.

With the Spicer Electrified™ TM4 SUMO™ LD system, vehicles can reach peak power of up to 270 kW, peak torque of up to 950 Nm, and operating speed up to 8,600 RPM. Designed and validated as per axle mount requirements, the system also offers seamless integration into Dana axles.

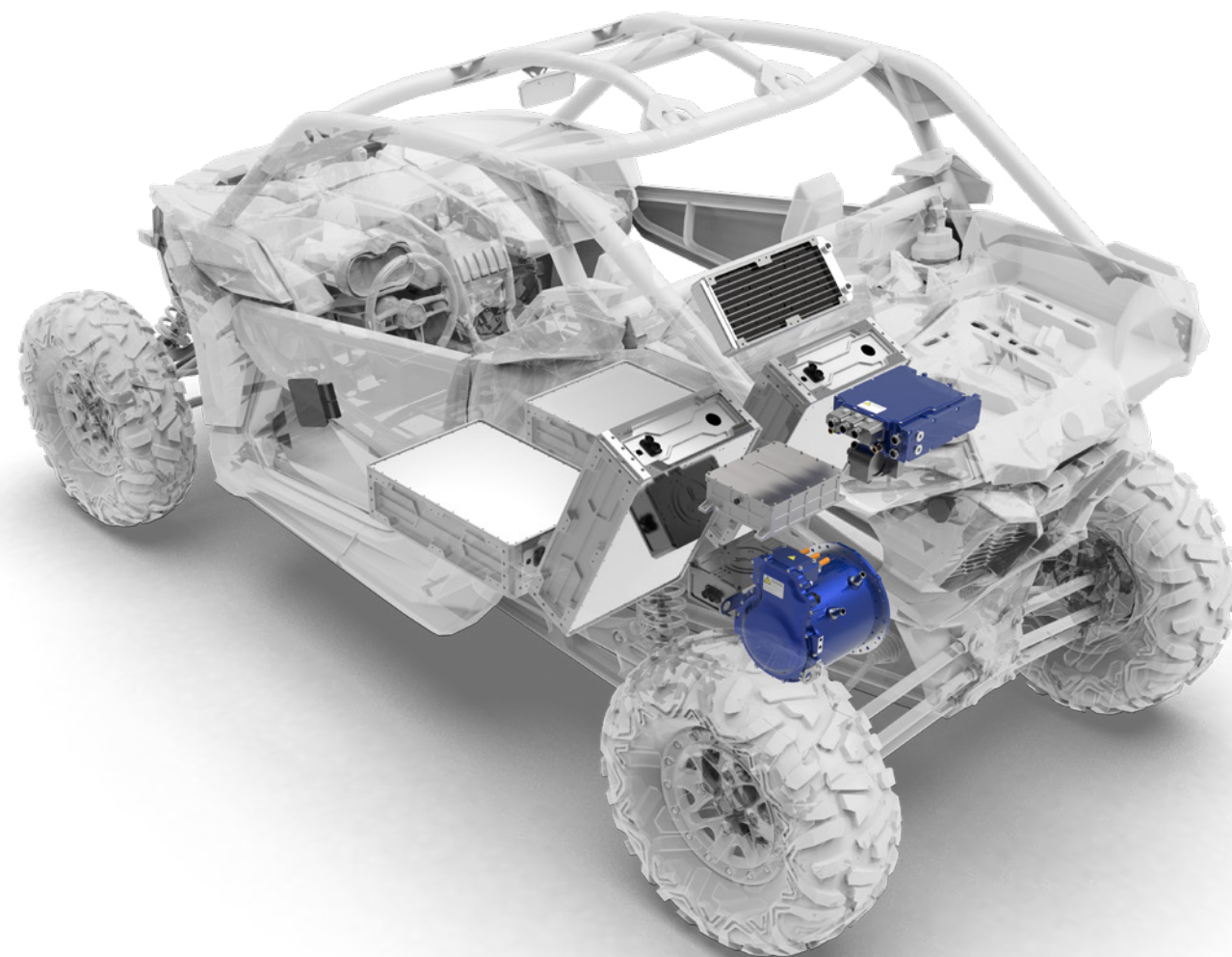

“I’m thrilled to lead a team supporting our customers through one of the biggest revolutions in the transportation industry — engineering e-Mobility technologies powering a positive impact for our planet and future generations.”



**Jason Sidders**

Senior Manager, Advanced Powertrain Applications Engineering, United States



**Spicer Electrified™ eS4500i e-Drive Unit**

**e-Powertrain for OX Delivers® Trucks Developed by Dana for Emerging Markets**

Dana's operation in Birmingham, United Kingdom, was awarded a \$2.7 million grant to develop an e-Powertrain for OX Delivers — the world's first flat-pack utility vehicle destined for emerging markets in Africa. The grant supports Dana's work industrializing electrified powertrain technologies and was awarded by the Advanced Propulsion Centre (APC) — a non-profit organization that facilitates U.K. government funding to research and development projects supporting the delivery of net-zero emission vehicles.

The OX Delivers truck has been engineered to tackle the toughest terrain and will be shipped as a flat pack and assembled in the destination country. The truck is powered by Dana's Spicer Electrified™ eS4500i e-Drive Unit, which combines an electric motor, inverter, gearbox, and software in a complete e-Propulsion system.

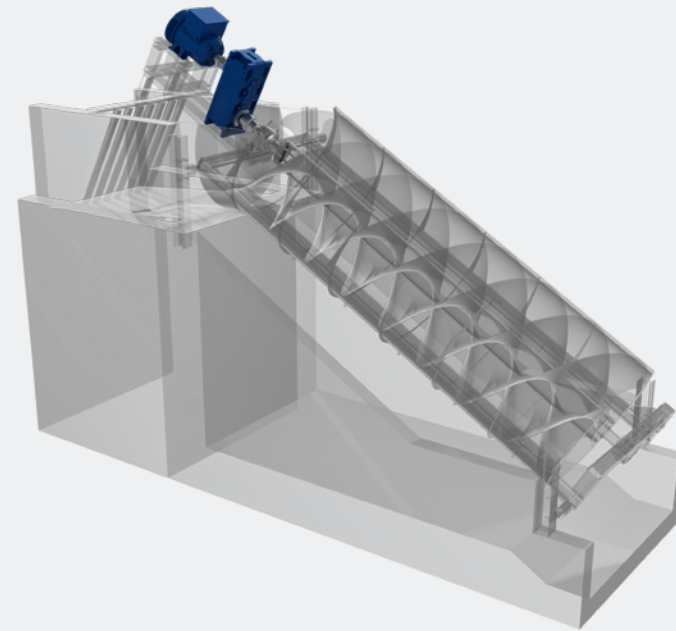

**Brevini EvoMax®**

**New Brevini EvoMax® Helical and Bevel-helical Gearbox Range Introduced for Marine, Offshore Applications**

As a leader in industrial gearboxes, Dana launched the Brevini EvoMax® series of helical and bevel-helical gearboxes for marine and offshore applications. The gearbox range introduces five completely new sizes and includes 14 redesigned gearboxes to provide higher torque, greater efficiency, and longer service. The modular series is designed to provide greater product flexibility, higher efficiency, and increased sustainability while helping to minimize total operating costs.

**eS15000r Rigid e-Axle**

**Dana Innovates with Electric Rigid Beam Axle**

Designed to meet the rigorous requirements of light-vehicle pickup trucks, Dana's electric rigid beam axle is a compact, robust 4-in-1 system capable of handling on- and off-road performance.

Dana believes a fully integrated rigid beam e-Axle is one of the most effective solutions for meeting the needs of the core truck buyer as they make the shift to an electrified vehicle. Rigid beam axles are capable of high towing capacities and heavy payloads with the added benefit of fewer components, packaging flexibility, greater customization, and a better overall return on investment.

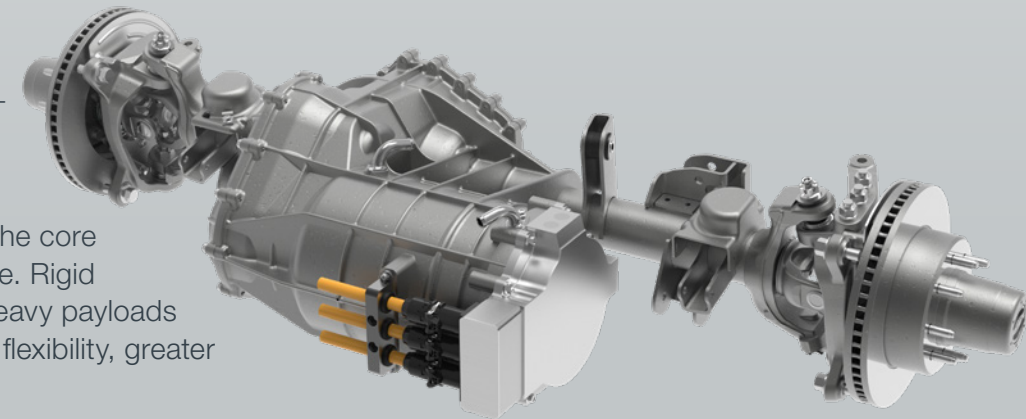

**Takeuchi® TB20e**

**Off-Highway Market Continues Shift to Electrification**

Dana continues to be at the forefront of meeting the needs of off-highway customers across varying applications. Dana's multi-market focus and scale has enabled it to find electrification growth and increased content per vehicle in new off-highway applications, including e-Mini excavators; low-voltage material handling; high-voltage drive systems for port equipment; low-voltage inverters for electric utility vehicles; access equipment; motorsport and recreational equipment; and lawn and turf care.





## Global Technology Centers

Dana's global network of 23 technology centers across 9 countries allow us to innovate near and with our customers.

Dedicated to the pursuit of new ideas, products, and services — they are home to more than 2,300 of the world's leading engineers, technicians, and scientists developing breakthrough advances in next generation clean-energy technologies and sustainable products.

We collaborate to drive diversity, push new boundaries, and deliver on-the-ground, local solutions for customers as they continue to accelerate their electric vehicle portfolio development.

We also recognize the importance of strong relationships with our academic partners. Our global network of universities throughout the Americas, Europe, and Asia provides a path for research and development, professional development education, and career opportunities transforming the future of mobility.



**Belgium**  
Brugge

**Brazil**  
Gravataí

**Canada**  
Boucherville, Quebec  
Laval, Quebec  
Oakville, Ontario

**China**  
Wuxi

**Germany**  
Bad Homburg  
Cologne  
Essen  
Neu-Ulm

**India**  
Pune

**Italy**  
Arco  
Reggio Emilia  
Rivoli  
Rovereto

**United Kingdom**  
Chudleigh  
Lindley

**United States of America**  
Lafayette, Indiana  
Maumee, Ohio (3)  
Paris, Tennessee  
Plymouth, Michigan



## Quality Signature

# Commitment to Excellence

Every day, each of us make around 30,000 decisions. Some are small. Others have a big impact.

At Dana, we power innovation to move our world. The vehicles and machines we develop support people’s lives. So, we take ownership of our actions.

Pursuing excellence. Operating to the highest standards. Having a zero-defect mindset. Being Quality Focused — All Day, Every Day.

It is why we received over 20 customer awards for our work in 2022 across multiple regions and product types.

And it is why we invested in continuous improvement and advanced tools to promote collaboration and global interconnectivity. All the while improving our sustainability footprint through waste elimination in our production processes.

### Blueprint for Consistency

During the year, we saw how the power of our Quality Focused strategy, systems, standards, and tools provide the blueprint for consistency — effectively increasing our performance and delivery.

Being problem solvers — People Finding A Better Way — gives us invaluable opportunities to gain experience in an open, “no blame” environment where we see challenges as treasures.

It builds relationships and trust.

Quality is a personal signature that motivates each of us to perform at the highest level. It gets to the core of ownership of and accountability for safety, quality, and sustainability.

### Operating System

Dana’s Quality Operating System is based on leading industry, quality, customer, and technical standards.

It includes the entire product lifecycle, from initial concept through design, development, production, and postproduction support.

It is comprehensive in design and inclusive of Environmental and Health and Safety management processes — utilizing a connected system of tools and methods tied to quality-focused behaviors and operational excellence.

### Quality Integration

Across our manufacturing operations, Dana invests in technologies that support a Quality Focused strategy.

Upstream, our Quality Focused methodology remained a key driver of product design and process development.

This ensured advanced quality deliverables in addition to closing the loop by electronically



## Quality Policy

We commit to customer satisfaction and deliver with **pride and passion**. We champion operational excellence and a **zero-defect approach**. We drive continuous improvement and remain “**Quality Focused All Day, Every Day.**”

*James K. Kamsickas*  
James K. Kamsickas  
Chairman and CEO





## Quality Signature

linking our product designs to a standard bill of process with the sole intention of defect prevention.

We continued the expansion of our operational excellence strategy through digital transformation including over 100 enhancements in digital shopfloor management, quality interlocks, and process capability reporting. To this end, Dana’s external auditors recognized our Quality Dashboard as “best in class”.

Our Read Across electronic app continued to communicate corrective actions, lessons learned, and best practices within our global footprint. By building in quality and doing it right the first time, we reduce the opportunity for nonconforming material. Through “Stop and Fix,” we are empowered to stop the line and identify a potential risk or issue.

On the product and equipment side of our business, we design for manufacturing

and assembly through our Stage Gate and Advanced Quality processes, which build in quality at the source.

And we have expanded our Quality Focused Digital Toolbox delivering rapid response and standardized processes for all Dana locations — including timing milestones and visual real-time data.

Our problem-solving approaches such as the “Plan Do Check Act” cycle advance our path to sustainability — whether it’s a product safety improvement, scrap reduction, or an efficiency project that reduces energy consumption.

We know that promoting standardization increases consistency and eliminates variation. This includes our Manufacturing Enterprise Systems along with our Connected 4.0 strategy — providing software solutions that advance quality and operational efficiencies into all our value streams.

### Changing Our World Through e-Propulsion

65 percent of Dana’s new business backlog now comes from innovating next-generation clean-energy technologies.

As we grow our electrification portfolio — including motors, inverters, and controls — we are continually expanding the use of quality systems earlier in the process to address control, detection, and compliance.

We have adapted to customer needs in this rapidly growing segment and can deliver all elements — from a component level to a complete, fully integrated electrified system — across any mobility market in anywhere in the world.

“We shape a more sustainable world, one vehicle at a time. Accelerating customers’ e-Propulsion journeys with fully integrated technologies and high-quality components.”

#### Ahmad Abu-Shaqra

Global Manufacturing Engineering Specialist, Germany





Quality Signature

# Customer Awards 2022



Supplier Quality Excellence Program -  
Gold Award  
**Jodalli, India**

Supplier Excellence Recognition  
Process - Excellent Level  
**Satara, India**

SQEP Platinum  
**Wellingborough, UK**



2021 Achiever Level Award  
**Global**

10PPM Award  
**Global**

2021 Quality Achievement  
**Neu-Ulm, Germany**



Best Supplier Award  
**Wuxi, China**



Overdrive Supplier of the Year 2021  
**Global**

Supplier of the Year 2021  
**Global**

Best Cooperative Supplier  
with Reliable Technology  
**Wuxi, China**

Certificate of Excellence Platinum  
Supplier Status  
**Neu-Ulm, Germany**

Supplier Quality Excellence Award  
**Ecuador  
Colombia  
Neu-Ulm, Germany**



Best Improvement Award 2021  
**Wuxi, China**



2022 Quality Quad Award  
**Chennai, India**



Best Quality Award  
**Wuxi, China  
Neu-Ulm, Germany  
Zaragoza, Spain**

Q1 Gold Award  
**Queretaro, Mexico**



**Mahindra**  
Best Quality Award  
**Anand, india**



Best Quality Supplier 2022  
**Bogota, Colombia**



Consistent Quality Performer  
**Pantnagar, India**  
Excellence Through Collaboration  
**Global**



Excellent Quality Performance Award  
**Global**



Best Process Alignment Award  
**Wuxi, China**

John Deere Achieving  
Excellence Program  
**Lafayette, USA**

Achieving Excellence -  
Partnership Level  
**Kolhapur, India**



Excellent Contribution Award  
**Wuxi, China  
Brugge, Belgium**

“Our world is unique, and our resources are the most precious thing we have. A small example of the many things we are doing in Argentina is composting waste from our cafeteria and giving employees organic soil to take back home.”

**Marysol Valdecantos**

Health and Safety Lead, Argentina







Acting **NOW** to  
protect our  
shared planet.



Sustainability in Action

# Sustainability Award Winners

Our annual Sustainability Awards spotlight some of the outstanding work from Dana teams around the world and the significance of their impact on the environment. The awards were presented by Doug Liedberg, chief compliance and sustainability officer at Dana.

## Best Sustainability Initiatives

### Gravataí, Brazil

Dana Gravataí, in Brazil, has been honored with the “Best Sustainability Initiatives” award for its commitment to environmental conservation and innovation. During the year, the plant undertook numerous sustainability projects addressing energy, waste, and water reduction, resulting in a greenhouse gas (GHG) emissions reduction of 8 percent.

One of the facility’s major achievements was the implementation of a solar energy generation project. On-site solar panels now generate an impressive 500 kW/day, eliminating 18 tons of GHG emissions per year.

Metric	Environmental Savings
<b>Waste</b> (4 projects)	28.1 tons CO <sub>2</sub>
<b>Energy</b> (3 projects)	39.2 tons CO <sub>2</sub>
<b>Logistics</b> (1 project)	21.0 tons CO <sub>2</sub>
<b>Water</b> (2 projects)	70.1 m <sup>3</sup>





Sustainability in Action

# Sustainability Award Winners



**Campus GHG Improvement\***

Scope 1 **69% reduction**  
 Scope 2 **29% reduction**

**Most Improved Facility**

Bad Homburg, Germany

Dana’s Bad Homburg plant has been awarded the title of “Most Improved Facility” for its remarkable transformation in 2022. Through a series of ambitious changes, the plant has become more efficient, modern, and sustainable, setting a example for other Dana manufacturing facilities.

One of the most significant achievements at the Bad Homburg plant is the major reduction in CO<sub>2</sub> emissions by revamping its internal operational layout and utilizing electrified transport.

Additionally, the Bad Homburg plant has modernized its lighting, converting 100 percent of its lighting to LED. This shift to energy-efficient lighting has not only reduced energy consumption but has also improved the overall working environment, providing brighter and safer conditions for the workforce.

Furthermore, the plant has made strides in replacing its compressed air and heating system, further optimizing energy usage and reducing its environmental impact.

\* Compared to 2019 campus data



**Most Innovative Sustainability Initiatives**

Åmål, Sweden

The Åmål facilities in Sweden received the award for the “Most Innovative Sustainability Initiatives” for their outstanding efforts and commitment to sustainable innovation.

Some of the key achievements include: the Silver level certification by the Sweden Green Building Council, installation of on-site solar generation contributing 436 MWh of clean energy annually, the installation of new electric vehicles (EV) charging stations, the implementation of a new EV corporate car

program, and the use of EV forklifts and autonomously-guided vehicles for internal transportation.

In addition, the Åmål facilities are utilizing 100 percent fossil-free energy from solar, wind, hydro, and nuclear power sources to power operations.

**100%** **Scope 1 and 2 emissions reduction**  
**Natural gas elimination**



## Supply Chain

# Driving a World-Class Sustainable Supply Chain

Dana has 88 major facilities strategically located across 31 countries on six continents.

We are committed to building a carbon-neutral supply chain and we work closely with suppliers to align their performance to meet our sustainability and social responsibility requirements — as reflected in our Supplier Standards of Business Conduct.

### Reach Your Goals

We know that our climate actions also impact your sustainability goals. We therefore closely benchmark and monitor our supply base to improve the sustainability performance across our supply chain — including the analysis of global Scope 3 GHG emissions.

We regularly score our suppliers based on several important attributes, including their ESG rating. We recognize that our performance, and the performance of our supply chain, is important to you and positively impacts your sustainability objectives.

### Strategically Located Near You

Because we operate near our customers all around the world, our global footprint shortens outbound delivery times, reduces the need for shipping, and enhances supply chain security. Our global team manages and tracks logistics across the entire supply chain. By optimizing our supply chain and the transportation required, we reduce our carbon footprint — and yours.

### Setting Standards

The Chartered Institute of Procurement and Supply (CIPS) recently awarded Dana with a Certificate of Procurement Excellence. This made us the first automotive company globally, and the first company in North America, to be recognized with the CIPS Procurement Excellence Award.

### Every Decision Counts

We drive sustainability and social responsibility as a key part of every purchasing decision. Our systematic and integrated approach empowers suppliers to be engaged. This includes our detailed evaluation process analyzing key considerations such as quality, total cost of ownership, ESG, inclusion and diversity, and risk mitigation.

### Investing in Our People

As part of our *People Finding A Better Way* culture, we are always focused on continuous improvement and talent development to ensure that our global purchasing team leverages best practices.

### Policy Action

As a company with global operations, we support the sourcing of raw materials and components responsibly. Respect for basic human rights and dignity is a fundamental part of our culture. We commit to carrying out business responsibly, sustainably, and ethically.

## What's in a Number?

**2,100** The number of production suppliers in more than 50 countries shipping to major Dana facilities.

**98%** The percentage of Dana strategic suppliers responding to a 2022 survey indicating that they had policies addressing each of six key areas — health and safety, human rights, employee diversity, sustainability, code of conduct, and information security.

**80%** Global production spend assessed through third party surveys in six key areas — climate impact, resource use, human trafficking and slavery, diversity and inclusion, and organizational commitment.

“It’s about working towards carbon-neutrality and driving social responsibility across our supply chain. This means advancing science-based targets and selecting suppliers taking real steps on climate action.”

### Tiina Palojaervi

Supply Chain Sustainability Manager,  
Switzerland





## Supply Chain



### Sustainability Supplier of the Year

We presented two Supplier Sustainability Awards 2022 to Bharat Forge (Pune, India) and Vallourec Tubos Do Brasil Ltda. (Sao Paulo, Brazil).

Both suppliers scored highly on Dana's sustainability ranking and aligned their strong sustainability programs with Dana's goals.



### Diverse Supplier of the Year

Our Diverse Supplier of the Year Award 2022 was presented to International Trade Winds, a supplier from Clarkston, Michigan, United States.

Our collaboration with International Trade Winds has grown over the 21 years they have been supplying parts to Dana. Throughout this time, diversity has played a significant part across their operations and efforts to deliver quality parts to our plants on time.

“We always take the bigger picture into account. We factor in suppliers’ track records on sustainability, human rights, and diversity. At the end of the day, we all share this planet and have a shared responsibility to build a better world.”



**Edgardo Castagnasso**  
Global Purchasing Director, United States

### Dana's Supplier Diversity Team Honored by Great Lakes Women's Business Council

In August 2022, Dana was presented with the Great Lakes Women's Business Council Excellence in Supplier Diversity Award for 2021.

This award is based on Dana's overall supplier diversity purchasing performance metrics — an honor demonstrating Dana's commitment to inclusion and diversity at every level of the business.

The “Best in Class” category is the highest-level award given and an indication that a corporation has excelled in all categories surveyed, including WBE spend, WBE capacity



building, corporate integration of supplier diversity, and advocacy of women-owned businesses.

The Great Lakes Women's Business Council helps to empower women and minorities economically through access to capital assistance programs, business development training, vendor certification, and business-to-business networking.



### Toyota Motor North America Award

Dana has been selected to receive Toyota's Excellent Supplier Diversity Award as part of Toyota Motor North America's 27th annual Supplier Business Meeting and Awards ceremony.



# Every Decision Counts

## Dana's Purchasing Decision Matrix



---

### Total Cost of Ownership

- Cost
- Working Capital
- Tariffs and Duties
- Logistics

---

### ESG

- Environmental
- Human Rights
- Safety
- Security
- Governance
- Compliance

---

### Inclusion and Diversity

- Women Owned
- Minority Owned
- Veteran Owned
- LGBTQ Owned
- Other Owned

---

### Quality

- Delivery
- Parts per Million Defective

---

### Collaboration

- Transparency
- Agility
- Technology

---

### Risk

- Performance
- Financial
- Geopolitical
- Reputation





**One Community.**



## Our Communities

**We take great pride in collaborating with organizations that are actively making a positive impact in our local communities.**

It is crucial for us to establish our identity and values within the community, so that we can build strong relationships and effectively contribute towards our shared goals.

We celebrate those teams and individuals who come together to build and nurture causes close to their heart and make a positive impact in the places where we do business and call home.

These include supporting students in underrepresented schools, donating food to local food banks, charity fundraising, cleaning roads and trails in local parks, and partnering with impactful, socially minded organizations.

Here are just a handful of examples of how our people around the world made a difference during the year.



### Photo Essay: Earth Day 2022

Earth Day is an annual event celebrated on April 22nd to raise awareness about environmental issues and to promote environmental protection. It was first celebrated in 1970, and since then, it has grown into a global occasion with participants from over 190 countries.

Earth Day is a time to reflect on our impact on the planet and to take action to protect the environment. The day is also an opportunity to advocate for policies and practices that can help reduce our environmental footprint and promote sustainability. Here are some snapshots of how our facilities around the world marked the occasion.



## Our Communities

### The Great American Clean-up

In June, employees from Dana's World Headquarters, participated in a roadside clean-up along US-23. The clean-up was held in partnership with the Ohio Department of Transportation's Keep Ohio Beautiful program and the Great American Cleanup.



### Looking Deeper at Inclusion

Dana in Brazil partners with people with moderate intellectual disabilities — such as members of our society who have Down Syndrome.

Each year across our Dana Gravataí operations, we organize a three-month training program — which combined with paid internships — gives our newcomers the time, resources, and support to be successful.



### Support to Ukraine

During the year, as thousands of Ukrainian citizens were forced to leave their homeland, Dana colleagues around the world extended a lending hand to those who have been impacted by the conflict.

In collaboration with local or larger European charity organizations, Dana teams collected money, food, clothing, medicines, and other necessities to assist those who were displaced.

Numerous plants in the region also teamed up with charities such as the Ukrainian Association of Residents and the Cancer Association to support the people who have had to leave their homes, jobs, and way of life.

Thank you to everyone, across the globe, who continues to do their part to support the Ukrainian people during their greatest time of need.



This award-winning, annual initiative is supported by hundreds of colleagues who volunteer annually to mentor our new hires in roles across kit assembly and packaging. Our apprentices and graduates inspire us every day, highlighting how working together we can advance diversity, equity, and inclusion in our society.

### AARG Group Supporting Children Sports

Our African American Resource Group (AARG), partners with employees to create a positive and inclusive impact within Dana and across the community.

During the year, Dana's AARG group in Lugoff, South Carolina, sponsored a local boys' and girls' basketball team in Kershaw County, with AARG members attending each game of the season.

In Michigan, Dana's Warren AARG group supported the Osborn High School girls' softball team and boys' baseball team. As well as cheering them on the field, AARG members spent time mentoring players and discussing education and career planning.



## Our Communities

### Dana Open Draws Players from 26 Countries

The 2022 Dana Open presented by Marathon — one of the longest running and most popular stops on the Ladies Professional Golf Association (LPGA) tour — took place from August 29 to September 4 at Highland Meadows Golf Club — about 15 minutes from Dana’s World Headquarters, in Maumee, Ohio.

Dana’s decision to be the title sponsor of this world-class LPGA tournament serves as a further example of our focus on diversity, equity, and inclusion.

We were excited to host all five 2022 major champions, at least 15 of the Top 20 players in the world, and more than 40 of the Top 50 money winners. Gaby Lopez from Spain rallied to earn her third career victory at the 2022 Dana Open presented by Marathon. The event has raised nearly \$13 million for children’s charities in its 37-year history.

The Dana Open 2023 takes place from July 10-16 again at the Highland Meadows Golf Club and continues to spotlight role models serving as an inspiration for others through their commitment to excellence.



2022 Dana Open Winner, Gaby Lopez



### Powering Brazil Operations

As part of a national effort to attract more women to manufacturing positions, Dana Brazil took the lead in establishing the Women Apprentices in Operations Program — offering paid training to prepare women for work at Dana.

Dana operations across Jundiaí, Campinas, and Sorocaba joined forces with SENAI (a federal government industry support group) and CIEE (offering internship programs for companies throughout Brazil) to create a training curriculum advancing topics such as metrology, technical drawing, quality, the 5S System, overview of Dana products, and more.

Now, 60 women are helping to bridge the gender gap and advance the United

Nation’s sustainable development objective of ensuring inclusive and equitable education and promoting lifelong learning opportunities for all.

### Entrepreneurs Fair

In addition, four simultaneous events across Dana Brazil facilities in Campinas, Gravataí, Jundiaí, and Sorocaba, promoted more than 70 women entrepreneurs to 1,500 Dana employees and their families.

This helped to broaden their business reach and engage employees in supporting these emerging women-owned businesses — further fostering Dana’s positive impact and key role in the community.

### Brazil Solidarity

During the year, Dana’s team in Brazil joined forces to make a difference for those less fortunate. Campaigns involved collecting and donating thousands of meals and food packs, clothes, mattresses, blood drive donations, and hundreds of school supply kits and toys to support groups assisting underprivileged children and the elderly.



### Dana Novi Bolstering Food Rescue

In August, Dana Novi colleagues in Michigan, United States, volunteered at Forgotten Harvest helping to prepare food donations for delivery to local charities.

The group packed enough to feed approximately 1,600 people. Forgotten Harvest is a non-profit food rescue organization that collects food that would otherwise go to waste and delivers it free of charge to organizations feeding those in need.



## Our Communities



### Giving Back at Dana China

Teams across Dana China are committed to giving back to the neighborhoods in which they operate — focusing on a range of community-based projects throughout the year.

For example, colleagues at the Dana Chongqing plant supported clean-up efforts in their local community forest and prepared gifts for children in mountainous areas and remote villages. By actively engaging in such projects, we hope to make a meaningful and sustainable impact.

### Dana Paris Sponsors SAE Mini-Baja

The team at the Dana Paris Technology Center, Tennessee, United States, sponsored the University of Tennessee “Martin’s 2022 Society of Automotive Engineers (SAE) Mini-Baja team” to support upcoming mechanical engineers.

Baja SAE challenges engineering students to build a prototype all-weather, rugged, single-seat, off-road recreational vehicle that will survive the severe punishment of rough terrains. These future engineers work together to resolve technical challenges in design, testing, and manufacturing.

Dana is also sponsoring the University of Toledo’s Formula SAE team, Michigan Technological University’s Formula SAE Electric team, as well as the team at the University of Waterloo Formula Motorsports in Ontario, Canada.



### Military and Veterans Group Awareness

In September, Dana’s Military and Veterans Business Resource Group sponsored the Christian’s Corner Foundation Run for Life to raise awareness and financial support for suicide prevention programs for both military and civilians.

The event took place at Dana’s World Headquarters in Maumee, Ohio and was headlined by a 5K run/walk, as well as a children’s one-mile fun run.

The Christian’s Corner Foundation Run for Life was a profound day that provided many people a place to come together to honor the memory of loved ones and show support for someone who may be experiencing behavioral health issues.



### Veterans Matters

In May, Dana’s Military and Veterans Business Resource Group hosted a pancake breakfast at our World Headquarters in Maumee, Ohio, United States, to raise awareness and funds for Veterans Matters

— an organization helping to find housing for homeless veterans.

Veterans Matters works directly with the U.S. Department of Veterans Affairs (VA) and local VA homeless programs to provide

rental deposits and first month’s rent for chronically unhoused veterans. The program integrates local communities, foundations, corporations, and veterans’ groups to house veterans and help them return to domestic autonomy.



### Science and Arts Students at Dana Warren

In August, the Dana Warren team in Michigan, United States, hosted 23 local middle school students who were attending a Science, Technology, Engineering, Arts, and Math camp through Macomb Community College.

It was an excellent opportunity for the students to learn more about Dana and experience how learning science, engineering, and arts apply to real-world applications that impact our day-to-day lives.



## Our Communities



### Distinguished Service Award

In May, Dana’s Legal Department was presented with a Distinguished Service Award on behalf of Dana and the Dana Charitable Foundation by the Legal Aid Society, an organization providing civil legal aid and advocacy to combat unfairness and injustice and to help people rise out of poverty.

Dana has a long history of service to legal aid for those in poverty and in 2013 created the Corporate Counsel Legal Aid Fellowship — a unique partnership among the counsel of major corporations in northwest Ohio and their outside law firms to fund the Medical-Legal Partnership for Children (MLPC).

The MLPC addresses the social determinants of health through partnering with area medical providers and has assisted nearly 3,500 people in poverty during this time. In addition, the Dana Charitable Foundation also provided ongoing support to Advocates for Basic Legal Equality and Legal Aid of Western Ohio, and in 2022 underwrote a local PBS documentary.

### Widening the Inclusion Network

In 2022, Dana graduated from the Ford WIN (Widening the Inclusion Network) program — designed to grow supplier diversity efforts through coaching, mentorship, and thoughtful partnerships with other diverse businesses.



Over recent years, Dana has worked with Ford to establish short-, medium-, and long-term goals around four focus areas, including diverse spend, advocacy group involvement, workforce diversity, and community outreach.

The WIN program is designed to expand opportunities available for diverse businesses as well as advance Dana’s economic impact.



## India Spotlight: The Dana Care Foundation

The Dana Care Foundation (DCF) is actively engaged in promoting six key social initiatives in India, which are geared towards empowering marginalized communities and making a significant impact on the lives of vulnerable populations.

These advocacy programs include education, vocational training, health and sanitation, rural upliftment, technology and R&D, as well as sustainability and disaster management.

Starting with a focus on education, DCF supports the Silver Lining Public School in Noida, educating 270 students all are from underprivileged backgrounds.

We also facilitate free midday meals and textbooks to all students and undertake similar work at two government schools at Sanand and Kolhapur by developing basic infrastructure and providing meals and uniforms.

Looking ahead, we sponsor higher education for 90 underprivileged students across Chennai, Hosur, Jodhalli, Manesar, Noida, and Satara regions — and deliver vocational training at Jodhali, Kolhapur, Noida, and Sanand to supporting the government’s “Skill India Mission” initiative.

### Effecting Positive Change

To help make a difference where people live, we work to enhance basic infrastructure such as establishing primary healthcare centers; water purification plants; and the construction of nurseries, primary schools, public libraries, and restrooms.

DCF is also actively involved in conserving the biodiversity of both rural and urban areas to promote clean air, water, and healthy soil. One of the major deliverables under this umbrella is the rejuvenation of ponds to promote and conserve ecosystems.

So far, we have deepened six ponds which has helped to enhance the fertility of the agricultural land in the region; raised the water level in the wells and thus the availability of clean, drinkable water; and improved irrigation for the five local villages near these projects.

As the pandemic continued throughout 2021, the Dana Care Foundation supported our communities by providing meals and dry rations, ventilators, medical beds, oxygen concentrators, as well as PPE kits and essential medicines.

Finally, to advance innovation through research and development and encourage a “start-up” ecosystem mentality in India, DCF partnered with leading universities such as the Indian Institute of Technology, the Indian Institute of Information Technology, the Vellore Institute of Technology, and the College of Engineering Pune and Amity University providing financial support to 17 projects themed under corporate social responsibility.

## United Way Initiatives

In August, Dana’s Humboldt and Paris facilities in Tennessee, United States, joined up to raise \$56,870 for the 2022 United Way campaign. The donations came from employee pledges and by sponsoring fun activities. Thanks to the generosity of both plants, they were recognized by the local

United Way chapter at the 2022 Celebration Breakfast.

In September, Dana teams at our Novi facility in Michigan, United States, came together to host a United Way fundraiser with volunteers coordinated a corn hole tournament and BBQ to help support their local United Way chapter.

In October, the Dana Lafayette team in Indiana supported the United Way by participating in Wabash Center Chip for a Cause. The Wabash Center assists those with disabilities and special needs by supporting individuals in their pursuit of quality of life for themselves and their families.



## Our Communities

### Support for Special Olympics

In June, Dana's Chairman and CEO Jim Kamsickas, along with Rod Filcek, AJGA Dana Incorporated Junior Open Tournament chair, presented a \$56,552 check to the Special Olympics of Lucas County, United States.



The donation helps to sponsor athletes and pay for transportation, uniforms, and fees in future events for the Special Olympics. Dana was also honored by the AJGA with the 2021 Charitable Giving Award, which is given to the tournament that raises the most money for charity. The 2022 AJGA Dana Incorporated Junior Open took place again in July.

### Dana Belgium Cycling Fundraising

In June, 45 employees from Dana Brugge in Belgium participated in a cycling race raising €5,000 for vzw Sterrenkinderen, an organization supporting grieving families struggling with the loss of a loved one. Thanks to all the volunteers helping to support deserving families and their communities.



### Metroparks Lecture Series Launch

Dana partnered with Metroparks Toledo to advance the construction and maintenance of Glass City Metropark and Riverwalk in East Toledo, Ohio, United States.

In April, we launched an annual lecture series spotlighting the significance of northwest Ohio's natural resources, the importance of protecting and restoring ecosystems, and ways the community can help the environment.

Glass City Metropark Phase 2, currently under construction, is a significant portion of the more than \$200 million Glass City Riverwalk — a 300- acre greenway on the east and downtown sides of the Maumee River from the Anthony Wayne Bridge to the Veterans Glass City Skyway.

When complete, the space will connect six neighborhoods along both sides of the Maumee River. Glass City Riverwalk is expected to become one of the region's most popular destinations, with year-round outdoor recreation opportunities, including adventure play areas and an ice-skating ribbon.

This investment in Metroparks is an extension of Dana's commitment to sustainability and social responsibility and will improve the environment and enrich the lives of people in the Toledo community for years to come.

### Dana Italia Holds Food Collection Initiative

In July, the Dana Italia team based in Arco, Italy, participated in a food drive to help support their local community.

More than 70 employees joined the initiative, which was held in collaboration with several local charities and 50 commercial enterprises. Together, they collected more than 10,000 kilos of donated food to distribute to families in need around the community.



### Dana Zaragoza Recognized for Inclusive Practices

In October, our team at Dana Zaragoza in Spain was honored by Arapack and Mapiser at their 25th-anniversary celebration for outstanding labor inclusion practices centered around working with disadvantaged groups, including disabled and those at risk of social exclusion. By partnering with these organizations, we support individuals in our communities who want to contribute and feel a sense of belonging and inclusion in society.



### Helping St. Jude Children's Hospital

In November, the Dana Dry Ridge team in Kentucky, United States, participated in the fourth annual Tin Cup Golf Open, an event that raises money for St. Jude Children's Hospital. The 7 iron-only scramble

included more than 90 golfers and raised \$10,000 for St. Jude's Children's Research Hospital — a pediatric treatment and research facility focusing on leukemia and other cancers.





**Corporate  
culture  
matters.**



## Leadership

### Board of Directors

**Ernesto M. Hernández**<sup>1, 4</sup>

Retired President and Managing Director of General Motors de México

**Director since 2022**

**Gary Hu**<sup>2, 4</sup>

Portfolio Manager for Icahn Capital LP

**Director since 2022**

**Brett M. Icahn**<sup>1, 3</sup>

Portfolio Manager for Icahn Capital LP

**Director since 2022**

**James K. Kamsickas**

Chairman and Chief Executive Officer of Dana Incorporated

**Director since 2015**

**Virginia A. Kamsky**<sup>2, 3\*</sup>

Chair and Chief Executive Officer of Kamsky Associates, Inc.

**Director since 2011**

**Bridget E. Karlin**<sup>3, 4</sup>

Senior Vice President of Information Technology at Kaiser Permanente

**Director since 2019**

**Michael J. Mack, Jr.**<sup>1\*, 2, 5</sup>

Retired Group President of John Deere Financial Services, Global Human Resources, and Public Affairs at Deere & Co.

**Director since 2018**

**R. Bruce McDonald**<sup>1, 2\*, 5</sup>

Retired Chairman and Chief Executive Officer of Adient plc

**Director since 2014**

**Diarmuid B. O’Connell**<sup>2, 4\*</sup>

Former Vice President of Tesla, Inc.

**Director since 2018**

**Keith E. Wandell**<sup>3, †</sup>

Retired President and Chief Executive Officer of Harley-Davidson, Inc.

**Director since 2008**

<sup>1</sup> Member: Compensation Committee  
<sup>2</sup> Member: Audit Committee  
<sup>3</sup> Member: Nominating and Corporate Governance Committee  
<sup>4</sup> Member: Technology and Sustainability Committee  
<sup>5</sup> Financial Expert  
\* Committee Chair  
† Lead Independent Director

 For full biographies, please refer to [Dana.com/investors](https://www.dana.com/investors)

### Corporate Officers

**James K. Kamsickas**

Chairman and Chief Executive Officer

**Aziz S. Aghili**

Executive Vice President and President of Heavy Vehicle

**Chris J. Clark**

Senior Vice President, Global Operations

**Jeroen B. Decler**

Senior Vice President, Off-Highway Drive and Motion Systems

**Christophe J. Dominiak**

Senior Vice President and Chief Technology Officer

**Byron S. Foster**

President, Light Vehicle Drive Systems

**Timothy R. Kraus**

Senior Vice President and Chief Financial Officer

**Ryan W. Laskey**

Senior Vice President, Commercial Vehicle Drive and Motion Systems

**Douglas H. Liedberg**

Senior Vice President, General Counsel, and Secretary, Chief Compliance and Sustainability Officer

**Maureen S. Pittenger**

Senior Vice President and Chief Human Resources Officer

**M. Craig Price**

Senior Vice President, Purchasing and Supplier Development

**Andrea Siudara**

Senior Vice President and Chief Information Officer

**Antonio Valencia**

President, Power Technologies and Global Electrification



## Ethics and Integrity

# World's Most Ethical Companies

Dana was recognized as one of the 2023 World's Most Ethical Companies® by Ethisphere, a global leader in defining and advancing the standards of ethical business practices.

In 2023, a total of 135 companies spanning 19 countries and 46 industries were recognized. Dana is one of only eight honorees across the mobility industry.

This prestigious recognition celebrates Dana's unwavering commitment to business integrity and recognizes a people-first culture where we foster exceptional stakeholder relationships through clear values and ethical standards.

We are committed to operating the business 'the right way,' with best-in-class ethics, compliance, and governance practices, as well as environmental and social impact programs.

### Tone From the Top

Across our global operating environment, one thing remains constant at Dana — our commitment to integrity and ethical business practices.

We have earned our customers' trust by delivering outstanding service and an unwavering commitment to ethics in all that we do, person to person.

For 120 years, we have been working together to build solutions that support vehicle and engine manufacturers around the world.

As we ship to more than 13,000 customers in 141 countries, each employee is obligated to act with the highest degree of integrity and in full compliance with the law.

### Business Conduct and Ethics

We believe that good corporate governance reinforces the message that Dana conducts business in a legal, ethical, and responsible manner with a respect for human rights.

At Dana, business conduct and ethics are addressed through various programs to maintain a culture where each of us feels comfortable asking questions, speaking up, and working toward solutions.

These processes include reporting, investigation and remediation, certification and audit, and continuous training and education.

Upon joining Dana, salaried employees undertake a series of mandatory new hire business conduct modules that include promoting honesty, integrity, mutual respect, and compliance with all our policies.

We believe in ongoing training and education to ensure that employees take an active role to understand the policies affecting their job and well-being applicable at their location.

In 2022, mandatory training for employees covered anti-harassment, effective trade compliance, protection against ransomware, and surviving an active threat.

Additional modules on ethics and compliance are also regularly integrated into other training initiatives from in-person team meetings and town halls to video messages, newsletters, and podcasts — all helping to drive a culture of ethics across the organization.

## Ethics and Compliance

Dana's Standards of Business Conduct are the cornerstone of our business ethics and compliance outreach — providing guidance to Dana people regarding specific legal and business conduct risk areas.

Dana also maintains other core corporate, operational, and functional policies that govern the conduct of all employees.

The on-boarding process for new hires involves a written acknowledgment of the receipt of the Standards of Business Conduct and other policies.

In addition, all salaried employees are expected to complete an annual questionnaire designed to identify any business conduct concerns.

Dana has a specific policy for handling internal investigations of possible business conduct and ethics violations and other matters involving fraud, theft, ethics, or financial reporting concerns.

This policy establishes an affirmative obligation for employees to report ethics and business conduct matters that come to their attention. It also identifies the process for handling investigations, oversight, reporting, and related issues.

[See our Standards of Business Conduct](#)

## Ethics and Compliance Helpline

Dana maintains a global Ethics and Compliance Helpline, a valuable communication tool available in multiple languages (by both telephone and e-mail) that Dana people may use to anonymously raise concerns related to any alleged ethics or business conduct matters outside of their normal reporting channels.

In 2022, Dana's Ethics and Compliance system logged 232 cases, of which 10

percent were found to be substantiated after investigation.

Here, Dana's response was based on the facts involved in the matter and included coaching, or other formal discipline.

We continue to drive our business in an ethical manner to help ensure the long-term success for our people, our customers, our communities, and our shareholders.



## Ethics and Integrity

# Standards of Business Conduct

Our Standards of Business Conduct set forth the behavioral expectations we have of our people as we conduct our operations around the world.

They cover a range of subjects including respect in the workplace, environmental protection, health and safety, use of corporate assets, conflicts of interest, and protection of confidential information among many other topics.

The Standards apply to all employees of Dana. We also expect that anyone acting on our behalf — including contractors, consultants, and other third parties — will observe the same high standards of business conduct and fulfill their contractual obligations.

Dana employees have a responsibility to:

- **Conduct business legally and ethically.** To know and comply with our Standards of Business Conduct, as well as the laws, regulations, and policies that apply to their location and role at Dana.
- **Ask for guidance.** To reach out any time they are unsure of the proper course of action. This includes their supervisors, the Dana Law Department, Human Resources, or the Internal Audit Department.
- **Share concerns if misconduct is suspected.** To realize that doing nothing or looking the other way is never acceptable and can have serious consequences for them and our company.
- **Never compromise.** To always conduct business the right way — and with the right values — consistent with our Standards.

# Supplier Code of Business Conduct

Dana operates at scale. We employ 42,000 people across 88 major facilities in 31 countries. We ship to 13,000 customers in 141 countries. We recognize that Dana is an essential component in a global supply chain serving customers worldwide.

We know that our performance, and the performance of our supply chain, is important to our customers and positively impacts their sustainability objectives.

Therefore, it is essential that our suppliers also understand and appreciate the standards of business conduct that are expected of any company that conducts business with Dana.

For that reason, we maintain a robust, interactive Supplier Code of Business Conduct that clearly communicates our business conduct expectations to Dana's suppliers. The Supplier Code of Conduct is also a contractual obligation in most Dana supply agreements.

Among a comprehensive list of standards, our code addresses:

- Respect for People: Inclusion and Diversity
- Safe and Positive Workplaces
- Environmental Protection and Sustainability
- Conflict Minerals and Other Product Origin Obligations
- Product Safety
- Gifts, Favors, and Entertainment
- Conflicts of Interest
- Negotiating Fairly and Honestly

To ensure we reinforce these values clearly and consistently around the world, our Standards of Business Conduct and our Supplier Code of Business Conduct have been translated into 20 languages and are publicly available on our website.

[See our Standards of Business Conduct](#)

[See our Supplier Code of Business Conduct](#)



# Cybersecurity Spotlight

Dana’s global cybersecurity team ensures compliance and safeguards our entities and assets against threats to our systems, operations and reputation.

Cybersecurity is the practice of protecting the confidentiality, integrity, and availability of assets (data, systems, networks, and programs) from digital attacks.

A priority focus on operational excellence and ensuring that systems are maintained and upgraded has been key to protecting Dana and our customers.

Throughout 2022, Dana cybersecurity teams further advanced governance, risk and compliance functions, data protection, and expanded security operations functionality and monitoring.

In addition, identity management improvements included the implementation of a Privileged Access Management system while continuing to centrally manage Dana’s domain.

Dana continues to focus on the cybersecurity culture and awareness of our employees. Mandatory training is administered

and monitored, maintaining over a 99% completion rate across the globe. Ongoing simulated phishing campaigns are conducted to gauge Dana’s risk exposure to attacks and follow-up training is assigned as needed.

Dana also conducts tabletop exercises and business continuity reviews for key insights on cybersecurity incident response program.

Dana’s Information Security Policy aligns to ISO 27001 and follows the National Institute of Standards and Technology (NIST) framework controls. We conduct self-assessments each year and third-party audits against the NIST framework.

Four key tenets — Operational Excellence, Technology, Business Continuity and Recovery, and Partnerships — underpin Dana’s robust cyber security strategy as it engages across the entire company to protect our people and increasingly digitized business operations.





The image features a dark blue background with a landscape of wind turbines. A large, semi-transparent blue oval in the center contains the word "Appendix" in white. The scene is overlaid with various data visualization elements: a large white circle with a dashed line of blue diamonds around its perimeter, several smaller white circles, and a series of concentric white circles on the left side. The wind turbines are silhouetted against a lighter blue sky, with a few smaller ones visible in the distance. The overall aesthetic is clean and modern, suggesting a technical or scientific context.

# Appendix



## Methodology

Using the Global Reporting Initiative (GRI), Sustainable Accounting Standards Board (SASB), Task Force on Climate-related Financial Disclosures (TCFD), and United Nations Sustainable Development Goals (SDGs) guidance, we identified possible topics, prioritized the topics, validated the results, and adopted the list of material topics for our Sustainability and Social Responsibility reporting strategy.

### Step 1: Identification

- Identified internal and external sources of information to score for prioritization.
- Benchmarked our competitors/peers on sustainability and social responsibility practices.
- Created a high-level value chain map to identify sustainability and social responsibility impacts, risks, opportunities, and boundaries.

### Step 2: Prioritization

- Gathered perceptions of stakeholder priorities based on associated facts and evidence, including 18 internal stakeholder interviews, 21 external stakeholder interviews, and internal/external score sourcing.
- Scored and synthesized feedback to present final materiality results reflecting feedback from stakeholders, peer benchmarking, and relevant industry standards and studies.

### Step 3: Validation

- Validated the materiality matrix through discussion with key leaders about prioritized material topics, associated boundaries, and opportunities.

### Step 4: Adoption

- Determined and/or refined the management approach regarding the most significant topics.
- Set or refined goals, performance indicators, strategies, partnerships, and internal controls.
- Established the materiality assessment as the basis for ongoing ESG strategy, goal setting, and reporting.

### Material Topics

Issues

1. Innovation and Product Lifecycle
2. Talent Management
3. Occupational Health, Safety and Wellness
4. Ethical Business Practices
5. Diversity and Equal Opportunity
6. Business Continuity / Risk Mitigation / Supply Chain
7. Product Quality and Safety
8. Energy Consumption and Emissions
9. Solid Waste
10. Water and Effluents

## Stakeholder Engagement

Continuous engagement and regular dialogue with our seven defined stakeholder groups, through formal and informal processes, provides us the opportunity to innovate and proactively manage the emerging environmental, social, and governance (ESG) needs and risks.

In addition to ongoing internal stakeholder engagement, we regularly engage with our external stakeholders on trending and emerging issues that matter to them through inquiries and requests for information related to our ESG practices as well as through periodic surveys answered at the request of various customers and investors.

In addition to engaging with internal and external stakeholders to evolve our ESG execution, we understand that increased transparency helps us effectively improve our business over the long term.

### A list of external charters and associations Dana is actively engaged with include:

- American Bar Association Diversity & Inclusion Initiative
- American Society of Safety Professionals (ASSP)
- Association of Equipment Manufacturers (AEM)
- Automotive Industry Action Group (AIAG)
- Board of Certified Safety Professionals (CSP)
- CEO Action for Diversity & Inclusion
- Center for Automotive Diversity, Inclusion & Advancement (CADIA)
- Chartered Institute of Procurement & Supply (CIPS)

- CDP (fka Carbon Disclosure Project)
- Ethisphere Institute
- Global Reporting Initiative (GRI)
- Great Lakes Women's Business Council (Great Lakes WBC)
- Human Rights Campaign Corporate Equality Index
- Institute of Hazardous Materials Management (IHMM)
- Institutional Shareholder Services (ISS)
- International Organization for Standardization (ISO)
- Leadership in Energy & Environmental Design (LEED)
- Manufacturers Alliance for Productivity and Innovation (MAPI)
- National Institute of Standards and Technology (NIST)
- National Society of Black Engineers (NSBE)
- S&P Global Corporate Sustainability Assessment (CSA)
- Science Based Target Initiative (SBTi)
- Sustainable Accounting Standards Board (SASB)
- United Nations Global Impact
- United Nations Sustainable Development Goals (SDGs)
- Task Force on Climate-related Financial Disclosures (TCFD)



# United Nations Sustainable Development Goals Index

The Global Reporting Initiative (GRI) is the independent international organization that helps businesses and other organizations take responsibility for their impacts, by providing global common language to communicate those impacts. They provide the world's most widely used standards for sustainability reporting — the GRI Standards.

The 2030 Agenda for Sustainable Development, adopted by all United Nations Member States in 2015, provides a shared blueprint for peace and prosperity for people and the planet, now and into the future. At its heart are the 17 Sustainable Development Goals (SDGs), which are an urgent call for action by all countries — developed and developing — in a global partnership. They recognize that ending poverty and other deprivations must go hand-in-hand with strategies that improve health and education, reduce inequality, and spur economic growth — all while tackling climate change and working to preserve our oceans and forests.

Within the report index, Dana is providing the linkages between the reporting framework content — Global Reporting Initiative, Sustainable Accounting Standards Board (SASB), and Task Force on Climate-related Financial Disclosures (TCFD) — and their relationship with the 17 United Nations SDGs listed to the right.

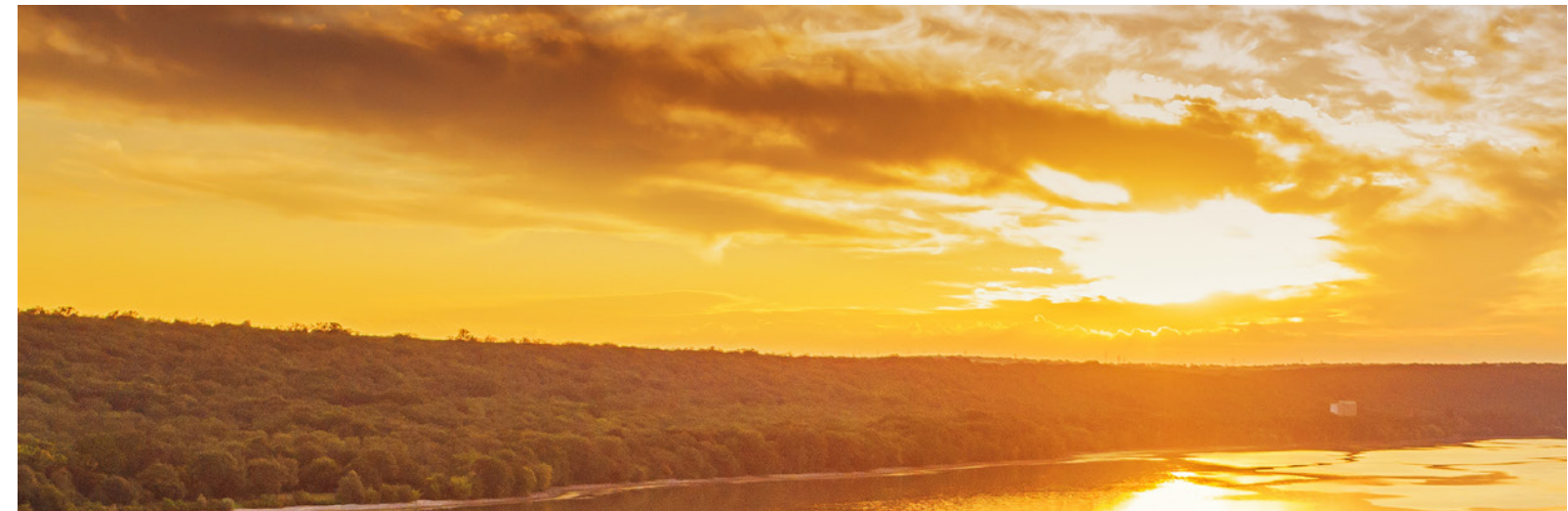

## SDG 13 Example: Brazil

### 100% Clean Energy Powered

The International REC Standard Foundation (I-REC Standard) is a non-profit organization that provides a robust standard for tracking climate actions.

Dana Brazil received I-REC certification attesting that the company's operations were 100% powered by renewable energy in 2022.

The majority of the energy generated came from hydroelectric plants, with other renewables such as wind and solar in the mix.

Additional emissions reduction actions in Brazil, such as the adoption of electric forklifts and the implementation of organic-waste composting across all facilities, have further assisted Dana's global target of more than 75 percent reduction of Scope 1 and Scope 2 GHG emissions by 2030.

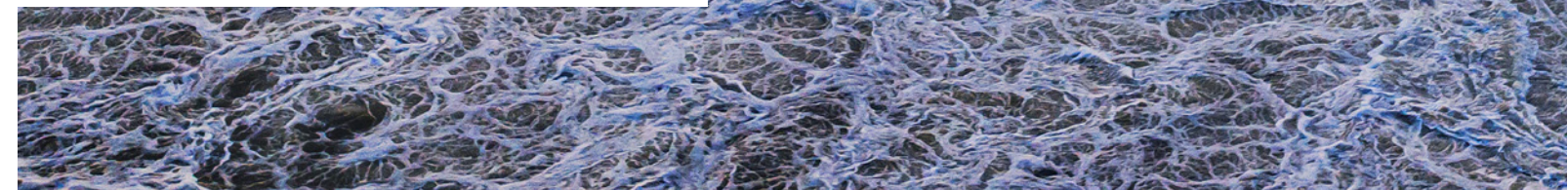



## Global Reporting Initiative (GRI) Index

The Global Reporting Initiative is the independent international organization that helps businesses and other organizations take responsibility for their impacts, by providing global common language to communicate those impacts. They provide the world’s most widely used standards for sustainability reporting – the GRI Standards.

Disclosure Number	Disclosure Title	2022 Response	SDGs
<b>GRI 102: General Disclosures</b>			
<b>Organizational Profile</b>			
102-1	Name of the organization	Dana Incorporated	N/A
102-2	Activities, brands, products, and services	Dana 2022 Sustainability & Social Responsibility Report: Dana: Overview <a href="#">Dana 2022 Annual Report</a> , pages 1 - 17	N/A
102-3	Location and headquarters	Dana’s corporate offices are located at:  Dana Incorporated 3939 Technology Drive Maumee, OH 43537, USA	N/A
102-4	Location of operations	<a href="#">Locations</a>	N/A
102-5	Ownership and legal form	Dana Incorporated (NYSE: DAN) is a publicly held corporation incorporated in the state of Delaware. Our shares trade on the New York Stock Exchange.	N/A
102-6	Markets served	Dana 2022 Sustainability & Social Responsibility Report: Overview / 2022 Sales <a href="#">Dana 2022 10-K</a> , pages 1 & 2	N/A
102-7	Scale of the organization	Dana 2022 Sustainability & Social Responsibility Report: Overview / 2022 Sales <a href="#">Dana 2022 10-K</a> , page 3 & 4	N/A
102-8	Information on employees and other workers	Dana 2022 Sustainability & Social Responsibility Report: Overview / Employment Data <a href="#">Dana 2022 10-K</a> , pages 5 & 6	N/A
102-9	Supply chain	Dana 2022 Sustainability & Social Responsibility Report: Taking Action / Driving a World-Class Sustainable Supply Chain <a href="#">Dana 2022 10-K</a> , page 3	N/A
102-10	Significant changes to the organization and its supply chain	Dana 2022 Sustainability & Social Responsibility Report: Taking Action / Driving a World-Class Sustainable Supply Chain <a href="#">Dana 2022 10-K</a> , pages 15 - 17	N/A
102-11	Precautionary principle or approach	Dana has applied the precautionary principle in its approach to managing greenhouse gas emissions and their effect on global climate change.	N/A
102-12	External initiatives	Dana 2022 Sustainability & Social Responsibility Report: Appendix / Stakeholder Engagement	SDG 17
102-13	Membership of associations	Dana 2022 Sustainability & Social Responsibility Report: Appendix / Stakeholder Engagement	SDG 17



## Global Reporting Initiative (GRI) Index

Disclosure Number	Disclosure Title	2022 Response	SDGs
<b>Strategy</b>			
102-14	Statement from senior decision-maker	Dana 2022 Sustainability & Social Responsibility Report: Message from the CEO	N/A
102-15	Key impacts, risks, and opportunities	<a href="#">Dana 2022 10-K</a> , pages 7 - 13	N/A
<b>Ethics and Integrity</b>			
102-16	Values, principles, standards, and norms of behavior	Dana 2022 Sustainability & Social Responsibility Report: Culture Matters / Ethics and Integrity <a href="#">Standards of Business Conduct</a>	SDG 3
102-17	Mechanisms for advice and concerns about ethics	Dana 2022 Sustainability & Social Responsibility Report: Culture Matters / Ethics and Integrity <a href="#">Internal Investigations Policy</a>	SDG 16
<b>Governance</b>			
102-18	Governance structure	Dana 2022 Sustainability & Social Responsibility Report: Culture Matters / Leadership <a href="#">Technology &amp; Sustainability Committee</a> <a href="#">Sustainability &amp; Social Responsibility Governance</a>	SDG 16
102-19	Delegating authority	<a href="#">Technology &amp; Sustainability Committee</a> <a href="#">Sustainability &amp; Social Responsibility Governance</a>	SDG 16
102-20	Executive-level responsibility for economic, environmental, and social topics	<a href="#">Sustainability &amp; Social Responsibility Governance</a>	SDG 16
102-21	Consulting stakeholders on economic, environmental, and social topics	Dana 2022 Sustainability & Social Responsibility Report: Appendix / Methodology	SDG 16
102-22	Composition of the highest governance body and its committees	<a href="#">Board of Directors</a> <a href="#">Corporate Governance</a> <a href="#">Sustainability &amp; Social Responsibility Governance</a> <a href="#">Dana 2023 Proxy</a> , page 44	SDG 16
102-23	Chair of the highest governance body	<a href="#">Dana 2023 Proxy</a> , pages 39 - 41	SDG 16
102-24	Nominating and selecting the highest governance body	<a href="#">Corporate Governance</a> <a href="#">Dana 2023 Proxy</a> , pages 37 - 41 <a href="#">Director Selection and Retention Guidelines</a>	SDG 16
102-25	Conflicts of interest	<a href="#">Standards of Business Conduct Policy for Members of the Board of Directors</a>	SDG 16
102-26	Role of highest governance body in setting purpose, values, and strategy	<a href="#">Corporate Governance Guidelines</a>	SDG 16
102-27	Collective knowledge of highest governance body	<a href="#">Dana Board of Directors</a> <a href="#">Dana 2023 Proxy</a> , pages 3 - 41	SDG 16



## Global Reporting Initiative (GRI) Index

Disclosure Number	Disclosure Title	2022 Response	SDGs
102-28	Evaluating the highest governance body's performance	<a href="#">Corporate Governance Guidelines</a> , page 6 <a href="#">Dana 2023 Proxy</a> , page 42	SDG 16
102-29	Identifying and managing economic, environmental, and social impacts	<a href="#">Technology &amp; Sustainability Committee Charter</a> , page 1, items 5 - 7 <a href="#">Sustainability &amp; Social Responsibility Governance</a>	SDG 16
102-30	Effectiveness of risk management processes	<a href="#">Dana 2022 10-K</a> , pages 7 - 13 <a href="#">Dana 2023 Proxy</a> , page 43	SDG 16
102-31	Review of economic, environmental, and social topics	<a href="#">Sustainability &amp; Social Responsibility Governance</a> <a href="#">Dana 2023 Proxy</a> , page 45	SDG 16
102-32	Highest governance body's role in sustainability reporting	<a href="#">Technology &amp; Sustainability Committee Charter</a> <a href="#">Sustainability &amp; Social Responsibility Governance</a>	SDG 16
102-33	Communicating critical concerns	Go to <a href="https://www.dana.com">Dana.com</a> to find the latest investor relations information about Dana, including stock quotes, news releases, and financial data.  Requests for information may be directed to: Dana Incorporated Investor Relations P.O. Box 1000 Maumee, OH 43537, USA  E-mail: <a href="mailto:InvestorRelations@dana.com">InvestorRelations@dana.com</a> / Dana's Investor Line: 800-537-8823  Through this 24-hour phone service, a caller may leave their name with a message, and the call will be returned by a Dana representative.	SDG 16
102-34	Nature and total number of critical concerns	This information is considered confidential.	SDG 16
102-35	Remuneration policies	<a href="#">Dana 2023 Proxy</a> , pages 12 - 21	SDG 16
102-36	Process for determining remuneration	<a href="#">Dana 2023 Proxy</a> , pages 8 - 11	SDG 16
102-37	Stakeholders' involvement in remuneration	<a href="#">Dana 2023 Proxy</a> , page 52	SDG 16
102-38	Annual total compensation ratio	<a href="#">Dana 2023 Proxy</a> , page 34	SDG 16
102-39	Percentage increase in annual total compensation ratio	<a href="#">Dana 2023 Proxy</a> , page 34	SDG 16
<b>Stakeholder Engagement</b>			
102-40	List of stakeholder groups	Dana 2022 Sustainability & Social Responsibility Report: Appendix / Methodology	N/A
102-41	Collective bargaining agreements	Dana recognizes and supports freedom of association and collective bargaining rights as required by applicable law.	N/A



## Global Reporting Initiative (GRI) Index

Disclosure Number	Disclosure Title	2022 Response	SDGs
102-42	Identifying and selecting stakeholders	Dana 2022 Sustainability & Social Responsibility Report: Appendix / Methodology	N/A
102-43	Approach to stakeholder engagement	Dana 2022 Sustainability & Social Responsibility Report: Appendix / Methodology	N/A
102-44	Key topics and concerns raised	Dana 2022 Sustainability & Social Responsibility Report: Appendix / Methodology	N/A
<b>Reporting Practices</b>			
102-45	Entities included in the consolidated financial statements	<a href="#">Dana 2022 10-K</a> , page 13	N/A
102-46	Defining report content and topic Boundaries	Dana 2022 Sustainability & Social Responsibility Report: Appendix / Methodology	N/A
102-47	List of material topics	Dana 2022 Sustainability & Social Responsibility Report: Appendix / Methodology	N/A
102-48	Restatements of information	None	N/A
102-49	Changes in reporting	None	N/A
102-50	Reporting period	Dana 2022 Sustainability & Social Responsibility Report: Cover Page	N/A
102-51	Date of most recent report	April 2023	N/A
102-52	Reporting cycle	Dana 2022 Sustainability & Social Responsibility Report: Cover Page	N/A
102-53	Contact point for questions regarding the report	Please send any questions regarding the report to: <a href="mailto:sustainability@dana.com">sustainability@dana.com</a>	N/A
102-54	Claims of reporting in accordance with the GRI Standards	Dana 2022 Sustainability & Social Responsibility Report: Appendix / GRI Content Index	N/A
102-55	GRI content index	Dana 2022 Sustainability & Social Responsibility Report: Appendix / GRI Content Index	N/A
102-56	External assurance	The Dana 2022 Sustainability & Social Responsibility Report has not been externally reviewed and verified as of the release date.	SDG 16



## Global Reporting Initiative (GRI) Index

Disclosure Number	Disclosure Title	2022 Response	SDGs
<b>Topic-Specific Standards</b>			
<b>GRI 204: Procurement Practices</b>			
103-1	Explanation of the material topic and its boundary	Dana 2022 Sustainability & Social Responsibility Report: Appendix / Methodology	N/A
103-2	The management approach and its components	Dana 2022 Sustainability & Social Responsibility Report: Taking Action / Driving a World-Class Sustainable Supply Chain	SDG 12
103-3	Evaluation of the management approach	Dana 2022 Sustainability & Social Responsibility Report: Taking Action / Driving a World-Class Sustainable Supply Chain	SDG 12
204-1	Proportion of spending on local suppliers	Dana works with thousands of suppliers around the world, including many suppliers located near our customers' operations.	SDG 12
<b>GRI 205: Anti-Corruption</b>			
103-1	Explanation of the material topic and its boundary	Dana 2022 Sustainability & Social Responsibility Report: Appendix / Methodology	N/A
103-2	The management approach and its components	Dana 2022 Sustainability & Social Responsibility Report: Culture Matters / Ethics and Integrity	SDG 16
103-3	Evaluation of the management approach	Dana 2022 Sustainability & Social Responsibility Report: Culture Matters / Ethics and Integrity	SDG 16
205-1	Operations assessed for risks related to corruption	Dana has a robust internal audit program including audit procedures specifically focused on business conduct.	SDG 16
205-2	Communication and training about anti-corruption policies and procedures	Dana 2022 Sustainability & Social Responsibility Report: Culture Matters / Ethics and Integrity	SDG 16
205-3	Confirmed incidents of corruption and actions taken	Dana 2022 Sustainability & Social Responsibility Report: Culture Matters / Ethics and Compliance Hotline	SDG 16
<b>GRI 206: Anti-Competitive Behavior</b>			
103-1	Explanation of the material topic and its boundary	Dana 2022 Sustainability & Social Responsibility Report: Appendix / Methodology	N/A
103-2	The management approach and its components	Dana 2022 Sustainability & Social Responsibility Report: Culture Matters / Ethics and Integrity	SDG 16
103-3	Evaluation of the management approach	Dana 2022 Sustainability & Social Responsibility Report: Culture Matters / Ethics and Integrity	SDG 16
206-1	Legal actions for anti-competitive behavior, anti-trust, and monopoly practices	Dana's public filings would identify any significant pending proceedings.	SDG 16



## Global Reporting Initiative (GRI) Index

Disclosure Number	Disclosure Title	2022 Response	SDGs
<b>GRI 302: Energy</b>			
103-1	Explanation of the material topic and its boundary	Dana 2022 Sustainability & Social Responsibility Report: Appendix / Methodology	N/A
103-2	The management approach and its components	Dana 2022 Sustainability & Social Responsibility Report: Overview / Climate Action	SDG 12, 13
103-3	Evaluation of the management approach	Dana 2022 Sustainability & Social Responsibility Report: Overview / Climate Action	SDG 12, 13
302-1	Energy consumption within the organization	78.9% electricity purchased from traditional energy providers Dana 2022 Sustainability & Social Responsibility Report: Overview / Climate Action and the graph detailing Total Energy Consumption (MWh)	SDG 7, 12, 13
302-2	Energy consumption outside of the organization	Scope 3 emissions for 2022 will be included in the 2023 CDP submission	SDG 7, 12, 13
302-3	Energy intensity	Dana 2022 Sustainability & Social Responsibility Report: Overview / Climate Action  <b>Normalized Energy Consumption (kWh per hour worked)</b> 2019: 28.42 kWh per hour worked 2020: 27.89 kWh per hour worked 2021: 24.88 kWh per hour worked 2022: 23.22 kWh per hour worked  <b>Normalized GHG Emissions (kWh per mil \$ sales)</b> 2019: 234,979 kWh per mil \$ sales 2020: 244,323 kWh per mil \$ sales 2021: 208,702 kWh per mil \$ sales 2022: 181,224 kWh per mil \$ sales	SDG 7, 12, 13
302-4	Reduction of energy consumption	Dana 2022 Sustainability & Social Responsibility Report: Overview / Climate Action and the graph detailing Total Energy Consumption (MWh)	SDG 7, 12, 13
302-5	Reduction in energy requirements of products and services	Dana 2022 Sustainability & Social Responsibility Report: Innovation	SDG 9, 13
<b>GRI 303: Water &amp; Effluents</b>			
103-1	Explanation of the material topic and its boundary	Dana 2022 Sustainability & Social Responsibility Report: Appendix / Methodology	N/A
103-2	The management approach and its components	Dana 2022 Sustainability & Social Responsibility Report: Overview	SDG 12, 14
103-3	Evaluation of the management approach	Dana 2022 Sustainability & Social Responsibility Report: Overview	SDG 12, 14
303-1	Interactions with water as a shared resource	Water interactions for 2022 will be included in the 2023 CDP submission	SDG 12, 14
303-2	Management of water discharge-related impacts	Water discharge for 2022 will be included in the 2023 CDP submission	SDG 12, 14



## Global Reporting Initiative (GRI) Index

Disclosure Number	Disclosure Title	2022 Response	SDGs
303-3	Water withdrawal	<p>Dana 2022 Sustainability &amp; Social Responsibility Report: Overview</p> <p><b>Total Water Consumption (m³)</b>                      2019: 3,506,106 m³                      2020: 3,270,472 m³                      2021: 3,344,551 m³                      2022: 3,030,299 m³</p> <p><b>Total Normalized Water Consumption (m3 per hour worked)</b>                      2019: 0.0492 m³ per hour worked                      2020: 0.0525 m³ per hour worked                      2021: 0.0446 m³ per hour worked                      2022: 0.0382 m³ per hour worked</p> <p><b>Total Normalized Water Consumption (m3 per mil \$ sales)</b>                      2019: 407 m³ per mil \$ sales                      2020: 460 m³ per mil \$ sales                      2021: 374 m³ per mil \$ sales                      2022: 298 m³ per mil \$ sales</p>	SDG 6, 12, 14
303-4	Water discharge	Water discharge for 2022 will be included in the 2023 CDP submission	SDG 12, 14
303-5	Water consumption	Water consumption for 2022 will be included in the 2023 CDP submission	SDG 6, 12, 14
<b>GRI 305: Emissions</b>			
103-1	Explanation of the material topic and its boundary	Dana 2022 Sustainability & Social Responsibility Report: Appendix / Methodology	N/A
103-2	The management approach and its components	Dana 2022 Sustainability & Social Responsibility Report: Overview / Climate Action	SDG 7, 12, 13
103-3	Evaluation of the management approach	Dana 2022 Sustainability & Social Responsibility Report: Overview / Climate Action	SDG 7, 12, 13
305-1	Energy: Direct (Scope 1) GHG emissions	<p>Dana 2022 Sustainability &amp; Social Responsibility Report: Overview / Climate Action</p> <p><b>Scope 1 GHG Emissions (kg CO<sub>2</sub>-e):</b>                      2019: 162,407,000 kg                      2020: 133,223,000 kg                      2021: 145,236,000 kg                      2022: 142,868,991 kg</p> <p><b>2022 Scope 1 Energy Consumption by Type (MWh):</b>                      Natural Gas: 682,720 MWh                      LPG: 51,912 MWh                      Diesel: 10,538 MWh                      Gasoline: 247 MWh</p>	SDG 7, 12, 13



## Global Reporting Initiative (GRI) Index

Disclosure Number	Disclosure Title	2022 Response	SDGs
305-2	Energy: Indirect (Scope 2) GHG emissions	<p>Dana 2022 Sustainability &amp; Social Responsibility Report: Overview / Climate Action</p> <p><b>Scope 2 GHG Emissions (kg CO<sub>2</sub>-e)</b>                      2019: 455,435,000 kg                      2020: 388,347,000 kg                      2021: 401,322,000 kg                      2022: 355,339,692 kg</p> <p><b>2022 Scope 2 Energy Consumption by Type (MWh)</b>                      Grid Electricity: 863,999 MWh                      Renewable Electricity: 231,093 MWh</p>	SDG 7, 12, 13
305-3	Energy: Other indirect (Scope 3) GHG emissions	Scope 3 emissions information for 2022 will be included in the 2023 CDP submission.	SDG 7, 12, 13
305-4	GHG emissions intensity	<p>Dana 2022 Sustainability &amp; Social Responsibility Report: Overview / Climate Action</p> <p><b>Normalized GHG Emissions (kg CO<sub>2</sub>-e per hour worked)</b>                      2019: 8.67 kg CO<sub>2</sub>-e per hour worked                      2020: 8.38 kg CO<sub>2</sub>-e per hour worked                      2021: 7.28 kg CO<sub>2</sub>-e per hour worked                      2022: 6.29 kg CO<sub>2</sub>-e per hour worked</p> <p><b>Normalized GHG Emissions (kg CO<sub>2</sub> -e per mil \$ sales)</b>                      2019: 71,675 kg CO<sub>2</sub> -e per mil \$ sales                      2020: 73,399 kg CO<sub>2</sub> -e per mil \$ sales                      2021: 61,102 kg CO<sub>2</sub> -e per mil \$ sales                      2022: 49,056 kg CO<sub>2</sub> -e per mil \$ sales</p>	SDG 7, 12, 13
305-5	Reduction of GHG emissions	Dana 2022 Sustainability & Social Responsibility Report: Overview / Climate Action and graph detailing Total Greenhouse Gas Emissions (kg CO <sub>2</sub> -e)	SDG 7, 12, 13
305-6	Emissions of ozone-depleting substances (ODS)	5,527,896 kg included in the calculation for Scope 1 GHG emissions	SDG 7, 12, 13
305-7	Nitrogen oxides (NOx), sulfur oxides (SOx), and other significant air emissions	<p><b>Significant emissions from combustion of fuels in 2022, include:</b></p> <p>Particulate Matter: 13,582 kg                      Nitrogen Oxides: 187,563 kg                      Sulfur Oxides: 5,385 kg                      Carbon Monoxide: 109,480 kg                      Volatile Organic Compounds: 13,682 kg                      Hazardous Air Pollutants: 20 kg</p> <p>Calculation Source: AP-42 Fifth Edition, Tables 3.3-1, 10/96 Update</p>	SDG 12, 13
<b>GRI 306: Effluents and Waste</b>			
103-1	Explanation of the material topic and its boundary	Dana 2022 Sustainability & Social Responsibility Report: Appendix / Methodology	N/A
103-2	The management approach and its components	Dana 2022 Sustainability & Social Responsibility Report: Taking Action	SDG 12, 15
103-3	Evaluation of the management approach	Dana 2022 Sustainability & Social Responsibility Report: Taking Action	SDG 12, 15



## Global Reporting Initiative (GRI) Index

Disclosure Number	Disclosure Title	2022 Response	SDGs
306-1	Waste generation and significant waste-related impacts	Dana 2022 Sustainability & Social Responsibility Report: Taking Action 2022 Hazardous Waste by Treatment Method (kg) is currently being calculated 2022 Non-Hazardous Waste by Treatment Method (kg) is currently being calculated	SDG 12, 15
306-2	Management of significant waste-related impacts	Dana 2022 Sustainability & Social Responsibility Report: Taking Action Refer to 2022 Hazardous and Non-Hazardous Waste Data (above)	SDG 12, 15
306-3	Waste generated	Dana 2022 Sustainability & Social Responsibility Report: Taking Action Refer to 2022 Hazardous and Non-Hazardous Waste Data (above)	SDG 12, 15
306-4	Waste diverted from disposal	Dana 2022 Sustainability & Social Responsibility Report: Taking Action Refer to 2022 Hazardous and Non-Hazardous Waste Data (above)	SDG 12, 15
306-5	Waste directed to disposal	Dana 2022 Sustainability & Social Responsibility Report: Taking Action Refer to 2022 Hazardous and Non-Hazardous Waste Data (above)	SDG 12, 15
<b>GRI 307: Environmental Compliance</b>			
103-1	Explanation of the material topic and its boundary	Dana 2022 Sustainability & Social Responsibility Report: Appendix / Methodology	N/A
103-2	The management approach and its components	Dana 2022 Sustainability & Social Responsibility Report: Value Others / Safety First	SDG 13, 14, 15, 16
103-3	Evaluation of the management approach	Dana 2022 Sustainability & Social Responsibility Report: Value Others / Safety First	SDG 13, 14, 15, 16
307-1	Non-compliance with environmental laws and regulations	No significant fines and/or non-monetary sanctions were levied against any of our sites in 2022. <a href="#">Dana 2022 10-K</a> , page 7	SDG 13, 14, 15, 16
<b>GRI 308: Supplier Environmental Assessment</b>			
103-1	Explanation of the material topic and its boundary	Dana 2022 Sustainability & Social Responsibility Report: Appendix / Methodology	N/A
103-2	The management approach and its components	Dana 2022 Sustainability & Social Responsibility Report: Taking Action / Driving a World-Class Sustainable Supply Chain	SDG 12, 16
103-3	Evaluation of the management approach	Dana 2022 Sustainability & Social Responsibility Report: Taking Action / Driving a World-Class Sustainable Supply Chain	SDG 12, 16
308-1	New suppliers that were screened using the environmental criteria	Dana 2022 Sustainability & Social Responsibility Report: Taking Action / Driving a World-Class Sustainable Supply Chain	SDG 12, 16
308-2	Negative environmental impacts in the supply chain and actions taken	Dana 2022 Sustainability & Social Responsibility Report: Taking Action / Driving a World-Class Sustainable Supply Chain	SDG 12, 16



## Global Reporting Initiative (GRI) Index

Disclosure Number	Disclosure Title	2022 Response	SDGs
<b>GRI 401: Employment</b>			
103-1	Explanation of the material topic and its boundary	Dana 2022 Sustainability & Social Responsibility Report: Appendix / Methodology	N/A
103-2	The management approach and its components	Dana 2022 Sustainability & Social Responsibility Report: Overview / Employment Data	SDG 8
103-3	Evaluation of the management approach	Dana 2022 Sustainability & Social Responsibility Report: Overview / Employment Data	SDG 8
401-1	New employee hires and employee turnover	Dana 2022 Sustainability & Social Responsibility Report: Overview / Employment Data	SDG 8
401-2	Benefits provided to full-time employees that are not provided to temporary or part-time employees	Dana 2022 Sustainability & Social Responsibility Report: Value Others / Health and Well-Being Spotlight <a href="#">Dana 2022 10-K</a> , pages 5 & 6 <a href="#">Careers Website</a>	SDG 3, 8
401-3	Parental leave	This information is being collected and analyzed.	SDG 3, 8
<b>GRI 403: Occupational Health &amp; Safety</b>			
103-1	Explanation of the material topic and its boundary	Dana 2022 Sustainability & Social Responsibility Report: Appendix / Methodology	N/A
103-2	The management approach and its components	Dana 2022 Sustainability & Social Responsibility Report: Value Others / Safety First	SDG 3, 8
103-3	Evaluation of the management approach	Dana 2022 Sustainability & Social Responsibility Report: Value Others / Safety First	SDG 3, 8
403-1	Occupational health and safety management system	Dana 2022 Sustainability & Social Responsibility Report: Value Others / ISO 45001 Certification Goal Achieved	SDG 3, 8
403-2	Hazard identification, risk assessment, and incident investigation	Dana 2022 Sustainability & Social Responsibility Report: Value Others / ISO 45001 Certification Goal Achieved In 2022, all major manufacturing sites achieved certification to the ISO 45001 OHS Management System. Certified sites are required to implement a robust hazard identification, risk assessment and incident investigation process as a requirement for 3rd party certification.	SDG 3, 8
403-3	Occupational health services	Dana facilities maintain robust occupational health services while also protecting worker confidential information.	SDG 3, 8
403-4	Worker participation, consultation, and communication on occupational health and safety	Dana 2022 Sustainability & Social Responsibility Report: Value Others / ISO 45001 Certification Goal Achieved In 2022, all major manufacturing sites achieved certification to the ISO 45001 OHS Management System. Certified sites are required to implement a robust hazard identification, risk assessment and incident investigation process as a requirement for 3rd party certification.	SDG 3, 8
403-5	Worker training on occupational health and safety	Dana 2022 Sustainability & Social Responsibility Report: Value Others / EHSS Education Drive In 2022, all major manufacturing sites achieved certification to the ISO 45001 OHS Management System. Certified sites are required to implement a robust hazard identification, risk assessment and incident investigation process as a requirement for 3rd party certification.	SDG 3, 8



## Global Reporting Initiative (GRI) Index

Disclosure Number	Disclosure Title	2022 Response	SDGs
403-6	Promotion of worker health	Dana 2022 Sustainability & Social Responsibility Report: Value Others / Safety First Dana 2022 Sustainability & Social Responsibility Report: Value Others / Health and Well-Being Spotlight	SDG 3, 8
403-7	Prevention and mitigation of occupational health and safety impacts	Dana 2022 Sustainability & Social Responsibility Report: Value Others / Safety First	SDG 3, 8
403-8	Workers covered by an occupational health and safety management system	Dana 2022 Sustainability & Social Responsibility Report: Value Others / ISO 45001 Certification Goal Achieved	SDG 3, 8
403-9	Work-related injuries	Dana 2022 Sustainability & Social Responsibility Report: Value Others / Safety First and graphs detailing Lost Time Recordable and Recordable Incident Rates	SDG 3, 8
403-10	Work-related ill health	Dana 2022 Sustainability & Social Responsibility Report: Value Others / Safety First and graphs detailing Lost Time Recordable and Recordable Incident Rates	SDG 3, 8
<b>GRI 404: Training and Education</b>			
103-1	Explanation of the material topic and its boundary	Dana 2022 Sustainability & Social Responsibility Report: Appendix / Methodology	N/A
103-2	The management approach and its components	Dana 2022 Sustainability & Social Responsibility Report: Value Others / People Development	SDG 4, 8
103-3	Evaluation of the management approach	Dana 2022 Sustainability & Social Responsibility Report: Value Others / People Development	SDG 4, 8
404-1	Average hours of training per year per employee	Dana 2022 Sustainability & Social Responsibility Report: Value Others / EHSS Education Drive and People Development	SDG 4, 8
404-2	Programs for upgrading employee skills and transition assistance programs	Dana 2022 Sustainability & Social Responsibility Report: Value Others / People Development	SDG 4, 8
404-3	Percentage of employees receiving regular performance and career development reviews	Dana 2022 Sustainability & Social Responsibility Report: Value Others / People Development	SDG 4, 8
<b>GRI 405: Diversity &amp; Equal Opportunity</b>			
103-1	Explanation of the material topic and its boundary	Dana 2022 Sustainability & Social Responsibility Report: Appendix / Methodology	N/A
103-2	The management approach and its components	Dana 2022 Sustainability & Social Responsibility Report: Value Others / Diversity, Equity, and Inclusion	SDG 5, 8, 10
103-3	Evaluation of the management approach	Dana 2022 Sustainability & Social Responsibility Report: Value Others / Diversity, Equity, and Inclusion	SDG 5, 8, 10
405-1	Diversity of governance bodies and employees	Dana 2022 Sustainability & Social Responsibility Report: Value Others / Diversity, Equity, and Inclusion and Employment Data <a href="#">Board of Directors</a> <a href="#">Dana 2023 Proxy</a> , page 44	SDG 5, 8, 10
405-2	Ratio of basic salary and remuneration of women to men	This information is being collected and analyzed.	SDG 5, 8, 10



## Global Reporting Initiative (GRI) Index

Disclosure Number	Disclosure Title	2022 Response	SDGs
<b>GRI 406: Non-Discrimination</b>			
103-1	Explanation of the material topic and its boundary	Dana 2022 Sustainability & Social Responsibility Report: Appendix / Methodology	N/A
103-2	The management approach and its components	Dana 2022 Sustainability & Social Responsibility Report: Value Others / Diversity, Equity, and Inclusion	SDG 5, 8, 10
103-3	Evaluation of the management approach	Dana 2022 Sustainability & Social Responsibility Report: Value Others / Diversity, Equity, and Inclusion	SDG 5, 8, 10
406-1	Incidents of discrimination and corrective actions taken	Dana 2022 Sustainability & Social Responsibility Report: Culture Matters / Ethics and Integrity	SDG 5, 8, 10, 16
<b>GRI 414: Supplier Social Assessment</b>			
103-1	Explanation of the material topic and its boundary	Dana 2022 Sustainability & Social Responsibility Report: Appendix / Methodology	N/A
103-2	The management approach and its components	Dana 2022 Sustainability & Social Responsibility Report: Taking Action / Driving a World-Class Sustainable Supply Chain	SDG 12
103-3	Evaluation of the management approach	Dana 2022 Sustainability & Social Responsibility Report: Taking Action / Driving a World-Class Sustainable Supply Chain	SDG 12
414-1	New suppliers that were screened using the social criteria	Dana 2022 Sustainability & Social Responsibility Report: Taking Action / Driving a World-Class Sustainable Supply Chain	SDG 12
<b>Material Topic: Innovation and Product Lifecycle Management</b>			
103-1	Explanation of the material topic and its boundary	Dana 2022 Sustainability & Social Responsibility Report: Appendix / Methodology	N/A
103-2	The management approach and its components	Dana 2022 Sustainability & Social Responsibility Report: Innovation	SDG 8, 9, 13
103-3	Evaluation of the management approach	Dana 2022 Sustainability & Social Responsibility Report: Innovation	SDG 8, 9, 13
Misc.	Innovation	Dana 2022 Sustainability & Social Responsibility Report: Innovation <a href="#">Dana 2022 10-K</a> , page 5 (Engineering and Research and Development) <a href="#">Innovation and Technology</a> <a href="#">Markets</a> <a href="#">e-Mobility</a>	SDG 8, 9, 13
Misc.	Product Lifecycle Management	The information is being collected and will be reported at a later date	SDG 8, 9, 13



## SASB Index

The Sustainability Accounting Standards Board (SASB) is an independent nonprofit organization that sets standards to guide the disclosure of financially material sustainability information by companies to their investors. SASB Standards identify the subset of environmental, social, and governance (ESG) issues most relevant to financial performance.

Disclosure Number	Disclosure Name	2022 Response	SDGs
<b>Energy Management</b>			
TR-AP 130a.1.1	Total energy Consumption in gigajoules (GJ)	6,625,832 GJ in 2022; 1.4% decrease from 2021	SDG 7, 12, 13
TR-AP 130a.1.2	Percentage of grid electricity consumed	78.9% in 2022; Reduction of 20% in grid electricity compared to 2021 consumption of grid electricity	SDG 7, 12, 13
TR-AP 103a.1.3	Percentage of renewable energy consumed	21.1% in 2022; Dana has installed solar panels at several facilities, entered into an agreement with the Toledo Community Foundation to purchase electricity from a newly constructed solar array, commenced a long-term virtual power purchase agreement with NextEra Energy generating ~300,000 MWh of renewable electricity annually beginning December 2022, and purchased I-RECs for majority of Brazil electricity consumption.  Dana 2022 Sustainability & Social Responsibility Report: Overview / Climate Action	SDG 7, 12, 13
<b>Waste Management</b>			
TR-AP 150a.1.1	Total amount of waste generated in metric tons (MT)	Total waste generation is currently being calculated	SDG 12, 15
TR-AP 150a.1.2	Percentage of waste generated that was hazardous	Hazardous waste percentage is currently being calculated	SDG 12, 15
TR-AP 150a.1.3	Percentage of waste generated that was recycled	Recycled waste percentage is currently being calculated	SDG 12, 15
<b>Product Safety</b>			
TR-AP 250a.1.1	Total number of recalls issued	Dana had zero voluntary recalls in 2022.	SDG 9, 16
TR-AP 250.a.1.2	Total number of units that were subject to a recall	Zero involuntary recalls were issued to Dana in 2022.	SDG 9, 16
<b>Design for Fuel Efficiency</b>			
TR-AP 410a.1.1	Total revenue from products that are designed to increase fuel efficiency and/or reduce emissions during their use	<a href="#">Dana 2022 Annual Report</a> , page 4	SDG 8, 9, 13



## SASB Index

Disclosure Number	Disclosure Name	2022 Response	SDGs
<b>Materials Sourcing</b>			
TR-AP 440a.1.1	Strategic approach to managing risks associated with the use of critical materials in products	Dana does not use any of the critical materials listed in the standard. Dana has a policy and process to manage identified Conflict Minerals. Dana 2022 Sustainability & Social Responsibility Report: Culture Matters	SDG 9, 10, 12
TR-AP 440a.1.2	Identify the critical materials that present a significant risk to operations	Dana does not use any of the critical materials listed in the standard. Dana has a policy and process to manage identified Conflict Minerals. Dana 2022 Sustainability & Social Responsibility Report: Culture Matters	SDG 9, 10, 12
TR-AP 440a.1.3	Disclosure sufficient for the risk without compromising confidential information	Dana does not use any of the critical materials listed in the standard. Dana has a policy and process to manage identified Conflict Minerals. Dana 2022 Sustainability & Social Responsibility Report: Culture Matters	SDG 9, 10, 12
<b>Materials Efficiency</b>			
TR-AP 440b.1.1	Percentage of products sold, by revenue, that are recyclable	The information is being collected and will be reported at a later date.	SDG 9, 12
TR-AP 440b.1.2	Percentage calculated as the revenue from products sold that are recyclable divided by the revenue from all products sold		SDG 9, 12
TR-AP 440b.1.3	Limit to products that are automotive parts, components, and materials		SDG 9, 12
TR-AP 440b.2.1	Percentage of input materials that are derived from recycled or remanufactured content		SDG 9, 12
TR-AP 440b.2.2	Percentage calculated as the weight of input materials consumed derived from recycled or remanufactured content divided by the total weight of all input materials consumed		SDG 9, 12
<b>Competitive Behavior</b>			
TR-AP 520a.1.1	Total amount of monetary losses incurred during the reporting period as a result of legal proceedings associated with anti-competitive behavior regulations	Dana's public filings would identify any significant monetary losses.	SDG 9, 16
TR-AP 520a.1.2	Any adjudicative proceeding before a court, a regulator, an arbitrator, or otherwise	Dana's public filings would identify any significant pending proceedings.	SDG 9, 16
TR-AP 520a.1.3	Losses, including any monetary liabilities to the opposing parties or others, fines and other monetary liabilities incurred during the reporting period as a result of civil actions, regulatory proceedings, and criminal actions	Dana's public filings outline its financial status including recurring and non-recurring items. Any significant losses will be identified in this information.	SDG 9, 16
TR-AP 520a.1.4	Scope of monetary losses excluding legal and other fees and expenses incurred in its defense	Dana's public filings outline its financial status including recurring and non-recurring items. Any significant losses will be identified in this information.	SDG 9, 16
TR-AP 520a.1.5	Scope of the disclosure, including legal proceedings associated with the enforcement of relevant regulations	Dana's public filings outline its financial status including recurring and non-recurring items. Any significant losses will be identified in this information.	SDG 9, 16
TR-AP 520a.1.6	Scope of the disclosure, including legal proceedings associated with enforcement of relevant industry regulations promulgated by regional, national, state, and local regulatory authorities	Dana's public filings outline its financial status including recurring and non-recurring items. Any significant losses will be identified in this information.	SDG 9, 16



## TCFD Index

The Financial Stability Board established the Task Force on Climate-related Financial Disclosures (TCFD) to develop recommendations for more effective climate-related disclosures that could promote more informed investment, credit, and insurance underwriting decisions and, in turn, enable stakeholders to understand better the concentrations of carbon-related assets in the financial sector and the financial system’s exposures to climate-related risks.

Recommended Disclosure	2022 Response	SDGs
<b>Governance</b>		
a) Describe the Board’s oversight of climate-related risks and opportunities.	CDP Climate Change 2022 Report, Section C1.1  C1.1: Board committees have expanded oversight to include environmental, social and governance (ESG) issues receiving sustainability updates on all ESG issues, including climate change. On July 28, 2020, Dana Incorporated announced that its Board of Directors has established a standing Technology and Sustainability Committee focused on technological and environmental stewardship. The Technology and Sustainability Committee is responsible for assisting the Board with oversight relating to innovation, new technologies, and sustainability and social responsibility. Key areas of focus for the Committee include the strategy, implementation, and effectiveness of Dana’s research and development initiatives, emerging trends in science, technology, and related regulations, strategic approach to technical talent management, and sustainability and social responsibility activities. More information can be found at: <a href="https://www.dana.com/newsroom/press-releases/dana-incorporated-board-of-directors-establishes-technology-and-sustainability-committee/">https://www.dana.com/newsroom/press-releases/dana-incorporated-board-of-directors-establishes-technology-and-sustainability-committee/</a>	SDG 7, 12, 13
b) Describe management’s role in assessing and managing climate-related risks and opportunities.	CDP Climate Change 2022 Report, Section C1.2 <a href="#">Sustainability &amp; Social Responsibility Governance</a>	SDG 7, 12, 13
<b>Strategy</b>		
a) Describe the climate-related risks and opportunities the organization has identified over the short, medium, and long term.	CDP Climate Change 2022 Report, Section C2.3, C2.4, C2.5 and C2.6	SDG 7, 12, 13
b) Describe the impact of climate-related risks and opportunities on the organization’s businesses, strategy, and financial planning.	CDP Climate Change 2022 Report, Section C2.3, C2.4, C2.5 and C2.6	SDG 7, 12, 13
c) Describe the resilience of the organization’s strategy, taking into consideration different climate-related scenarios, including 2°C or lower scenario.	This information will be included in the 2023 CDP submission.	SDG 7, 12, 13
<b>Risk Management</b>		
a) Describe the organization’s processes for identifying and assessing climate-related risks.	CDP Climate Change 2022 Report, Section C2.2b	SDG 7, 12, 13
b) Describe the organization’s processes for managing climate-related risks.	CDP Climate Change 2022 Report, Section C2.2d	SDG 7, 12, 13
c) Describe how processes for identifying, assessing, and managing climate-related risks are integrated into the organization’s overall risk management.	CDP Climate Change 2022 Report, Section C2.2c	SDG 7, 12, 13



## TCFD Index

Recommended Disclosure	2022 Response	SDGs
<b>Metrics and Targets</b>		
a) Disclose the metrics used by the organization to assess climate-related risks and opportunities in line with its strategy and risk management process.	CDP Climate Change 2022 Report, Section C4.1	SDG 7, 12, 13
b) Disclose Scope 1, Scope 2, and if appropriate, Scope 3 greenhouse gas (GHG) emissions, and the related risks.	Dana 2022 Sustainability & Social Responsibility Report: Overview / Climate Action  <b>Scope 1 GHG Emissions (kg CO<sub>2</sub>-e):</b> 2019: 162,407,000 kg 2020: 133,223,000 kg 2021: 145,236,000 kg 2022: 142,868,991 kg  <b>2022 Scope 1 Energy Consumption by Type (MWh):</b> Natural Gas: 682,720 MWh LPG: 51,912 MWh Diesel: 10,538 MWh Gasoline: 247 MWh  <b>Scope 2 GHG Emissions (kg CO<sub>2</sub>-e)</b> 2019: 455,435,000 kg 2020: 388,347,000 kg 2021: 401,322,000 kg 2022: 355,339,692 kg  <b>2022 Scope 2 Energy Consumption by Type (MWh)</b> Grid Electricity: 863,999 MWh Renewable Electricity: 231,093 MWh	SDG 7, 12, 13
c) Describe the targets used by the organization to manage climate-related risks and opportunities and performance against targets.	CDP Climate Change 2022 Report, Section C4.1	SDG 7, 12, 13
<b>Transportation Group Metrics</b>		
a) Revenues/savings from investments in low-carbon alternatives (e.g. R&D, equipment, products or services)	This information will be included in the 2023 CDP submission.	SDG 7, 12, 13





*People Finding A Better Way<sup>®</sup>*